

The logo features a large, stylized black letter 'E' with a white outline and a grey shadow. To its right is a grey sphere with a white highlight. Below the 'E' and sphere, the word 'max' is written in a red, italicized, cursive font with a white outline. A small 'TM' trademark symbol is positioned to the right of 'max'. Below this, the word 'BingoConsole' is written in a large, bold, black, italicized sans-serif font.

E-max BingoConsole

Operators Manual

© E-max Gaming Corporation.
9900 Clinton Rd. Cleveland, Ohio 44144
Phone 216.961.3500 • Toll Free 800.321.0757

Part number: HH813
Revision 4
February, 2006

This manual should not be reproduced in any
manner without written consent from the E-max Gaming Corporation Inc.

Table of Contents

Introduction	i.
C H A P T E R 1	
Getting Started	1.0
Unpacking	1.1
Contacting Service	1.2
C H A P T E R 2	
Installation	2.0
Console Installation	2.1
Console Devices	2.2
Basic Controls	2.3
Electrical Installation	2.4
Powering up the Console	2.5
Flashboard, Video and Audio Installation	2.6
CHAPTER 3	
Ball Handling	3.0
Handling and Calling Balls	3.1
Calling a Ball	3.2
Resetting a Ball	3.3
Ball Tray System Failure	3.4
Manual Mode	3.5
Calling a Ball in Manual Mode	3.6
Resetting a Ball in Manual Mode	3.7
Resetting the Flashboard in Manual Mode	3.8
C H A P T E R 4	
Console Security System	4.0
C H A P T E R 5	
Quick Tour	5.0
Tutorial	5.1
System Startup	5.2
Playing Bingo	5.3
Verifying a Winner	5.4
Using the Toolbar	5.5

C H A P T E R 6	
System Programming	6.0
Creating and Editing a Bingo Session	6.1
Game Pattern Definitions	6.2
C H A P T E R 7	
Special Functions Wild Number Feature	7.0
Multimedia Functions	7.1
C H A P T E R 8	
Servicing & Cleaning	8.0
General Cleaning of your E-max Bingo System	8.1
Replacing the Graphics Panel Light	8.2
Replacing the Blower Air Filter	8.3
Replacing the Arm Rest	8.4
Cleaning the Ball Tray Chamber	8.5
C H A P T E R 9	
Troubleshooting & Diagnostics	9.0
UPS Status Indicators and Alarms	9.1
C H A P T E R 10	
Warranty Information	
C H A P T E R 11	
System Utilities	11.0
Back up CD	11.1
Restore Lost Game Data	11.2
Configure the Operating System	11.3
Install Software Updates	11.4
Touch Screen Calibration	11.5
Set the date and time	11.6
Testing the Flashboards	11.7
Gaming Log	11.8
payout Report	11.9
Gaming Report	11.10
Ball Frequency Report	11.11
Hardware Settings	11.12

A P P E N D I X A

Console Diagrams
Operator Console Block Diagram
Dell System Connectors for Video and Peripherals
Video and Audio Connections Block Diagram
Peripheral Device Connections Block Diagram
AC Power Connections
Data Router Console Side Connections
Data Router Field Side Connectors
Data Router Field Connector Pin Definitions
RF Modulator Connectors

A P P E N D I X B

Specifications

A P P E N D I X C

Wiring Diagrams
AC Outlet

1.0 Getting Started

The E-max™ Bingo Console was designed to have a distinctively attractive appearance, using careful manufacturing and assembly techniques to insure quality. The E-max™ Bingo Console is modular in design comprising of an electronics console and a ball console. Each is packaged in a separate shipping container. One system configuration uses two ball consoles with one electronic console. In this case, you will receive three shipping containers. Each Ball Console weighs approximately **165** pounds while the Electronics Console weighs about **196** pounds.



1.1 Unpacking Console

- ✓ Inspect the shipping containers for possible signs of damage. If damage is detected, refer to the Damage Action Process section (1.3) for procedures.
- ✓ Use scissors or box cutter to cut the straps from the skid only, taking care not to cut the straps protecting the console. With the help of at least one assistant, carefully slide the Ball Blower Section of the console from the skid and place it on solid flooring. Cut the remaining four straps from the console and remove the cardboard top.
- ✓ Remove the foam packing inserts from inside the top and slide the cardboard tube up and off the console. A minimum of two people are required to safely unpack the console. Never lift the Ball Blower section by the arm rest or any part of the ball chamber or ball catcher assembly (*lift only by the console top*). With one person lifting from each end of the console, raise the console up and out from the carton and foam inserts. Set the unpacked Ball Blower section on solid flooring. Check that all casters are in place. Do not destroy or discard carton or packing material until after final inspection and testing.
- ✓ Next, carefully slide the Electronics cabinet carton from the skid. Cut the remaining four straps from the carton and remove the cardboard top. Remove the foam packing inserts from inside the top and slide the cardboard tube up and off the console. A minimum of two people are required to safely unpack the console. Never lift the Electronics cabinet from the monitor arm or any part of the monitor. Ensure that all doors and drawers are secure before lifting. With one person lifting from each end of the Electronics cabinet, raise the console up and out from the carton and foam inserts. Set the unpacked electronics Cabinet section on solid flooring. Check that all casters are in place. Do not destroy or discard carton or packing material until after final inspection and testing.
- ✓ Unpack the keyboard from the cardboard box. Place the keyboard on the electronics cabinet in front of the touch screen monitor. Remove the mouse from the plastic bag and set next to the keyboard.
- ✓ At this point, you should inspect the consoles for any obvious shipping damage. If any problems are found, immediately contact your distributor for advice and refer to the Damage Action Process section (1.3) for procedures.

The following accessories should be found in the Ball Blower section of the console:

- (1) Hardware Kit to join cabinets (two aluminum U channels and sixteen 5/16" – 18 x 3/4" bolts with washers) (Figure 1.1)
- (1) Front Filler Panel
- (1) Rear Filler Panel; with cup holder
- (1) Rubber Bungee Cord
- (1) Set of Bingo Balls

The following accessories should be found in the Electronic Cabinet of the console:

- (1) Computer mouse
- (1) Computer keyboard
- (6) Keys for cabinet doors
- (1) State configuration and application CD
- (1) Recovery CD
- (1) Blank CD for Backups
- (1) Magnetic Reader Card

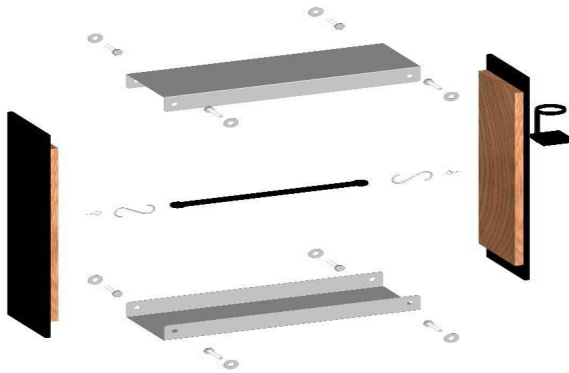

FIGURE 1.1

Hardware Kit to join cabinets (two aluminum U channels, sixteen 5/16" – 18 x 3/4" bolts with washers, bungee cord and two filler strips)

1.2 Contacting Service

For Service information or technical assistance, contact the

E-max Technical Assistance Center 1-800-277-6214

1.3 Damage Action Process

Your E-max™ Bingo Console contains delicate electronic equipment. It is imperative that you thoroughly inspect the contents of each package before accepting product delivery from the carrier.

In case of severe damage, refuse the equipment from the carrier. Contact your distributor for immediate replacement.

In case of damage, make a note on the bill of lading before accepting, take a photo of the damage, and keep the packaging to aid in recovering the amount of claim against the carrier.

If the product is damaged but acceptable, take a photo before and after unpacking as a record of the damage and contact the carrier's agent immediately for inspection. Be sure to obtain a copy of the inspection report for your records.

If these precautions are not taken, we cannot assist you in recovering the amount of the claim against the carrier.

2.0 Installation

Chapter

2

Required Tools

1. 3/16 inch Allen wrench
2. ¼ Socket Driver (torque)
3. 5/16 Socket
4. Socket Extension 4"

2.1 Console Installation

- ✓ Roll both (or all three) cabinets into the approximate place they will be used. Ideally you would like the console to be slightly elevated and centered in the hall. Position the two cabinets as close together as you can with the Ball Blower on the side selected by the hall manager, or place the electronics console in between the two ball consoles.
- ✓ Slide the first aluminum U channel between the cabinets along the bottom. Use eight of the 5/16" – 18 x ¾" bolts and washers to secure the bottom and sides of the two cabinets together (AT THIS POINT DO NOT TIGHTEN BOLTS COMPLETELY WHICH WILL PREVENT PROPER U CHANNEL ALIGNMENT). Next, install the top aluminum U channel using the same method described above. Next, Run the Ball tray computer, USB and ball chamber power cables through the holes provided, into the Electronics cabinet. (Refer to Section 2.4 for electrical installation procedures) Lastly, torque each bolt to between fifteen and twenty foot pounds to secure U Channel's in place.
- ✓ Unlock the Electronics Cabinet drawer and open about one inch. Unlock and open the Graphics Panel door on the Electronics cabinet. Using access provided by the graphics panel door, feed the three cables from the Ball Blower Cabinet into the Electronics Cabinet. Insert the front Filler Panel between the cabinets in front of the console (IF TWO BALL CONSOLES ARE PRESENT FEED SECOND GROUP OF THREE CABLES FROM SECOND BALL CONSOLE INTO ELECTROICS CONSOLE). Attach the rubber bungee cord to the eye hook. Next attach the other end of the rubber bungee cord to the rear Filler panel. (**Note: Ensure that the cup holder is facing up**) (Figure 2.1)
- ✓ Open the set of Atlas bingo balls. The E-max Gaming Corporation recommends ONLY Atlas bingo balls. Atlas bingo balls are multi-colored and double numbered. Other balls may have been specified for your system. Inspect each ball for damage and insert each ball into its corresponding slot in the ball tray to ensure the set is complete. Any problems, contact your distributor for a replacement.

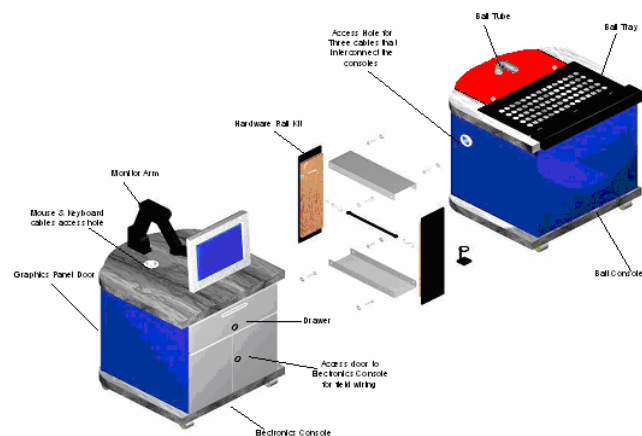

Figure 2.1

2.2 Console Devices

Electronics Cabinet Controls (**Figure 2.2**)

1. Dell CPU
2. UPS (Uninterruptible Power Supply) – Provides electrical power in the event of a primary power failure. It contains the battery pack.
3. Data Router – This provides the external interface for flashboards and hall video.
4. RF Modulator 1 – For Ball Monitor
5. RF Modulator 2 – For Message Monitor



Figure 2.2

2.3 Basic Controls

Ball Blower Cabinet Manual Controls (Figure 2.3) & (Figure 2.4)

1. Blower Switch – This is the On/Off switch for the ball blower motor
2. Ball Reset Switch and LED – This switch cancels the last ball inserted into the ball tray. (only active in Manual Mode when LED is ON)
3. Flashboard Reset Switch and LED – This switch clears all the called balls and flashboard. (only active in Manual Mode when LED is ON)
4. Ball Tray Switches – Insert ball and press down on the ball to activate the switch.
5. Two black ball release knobs – Releases balls into ball tray chamber.
6. Red Door Release knob - Releases balls into mixer chamber.
7. Ball Camera with light – Embedded digital camera and white light ball illumination.
8. Ball Tube – Centers balls extracted from mixing chamber over camera.

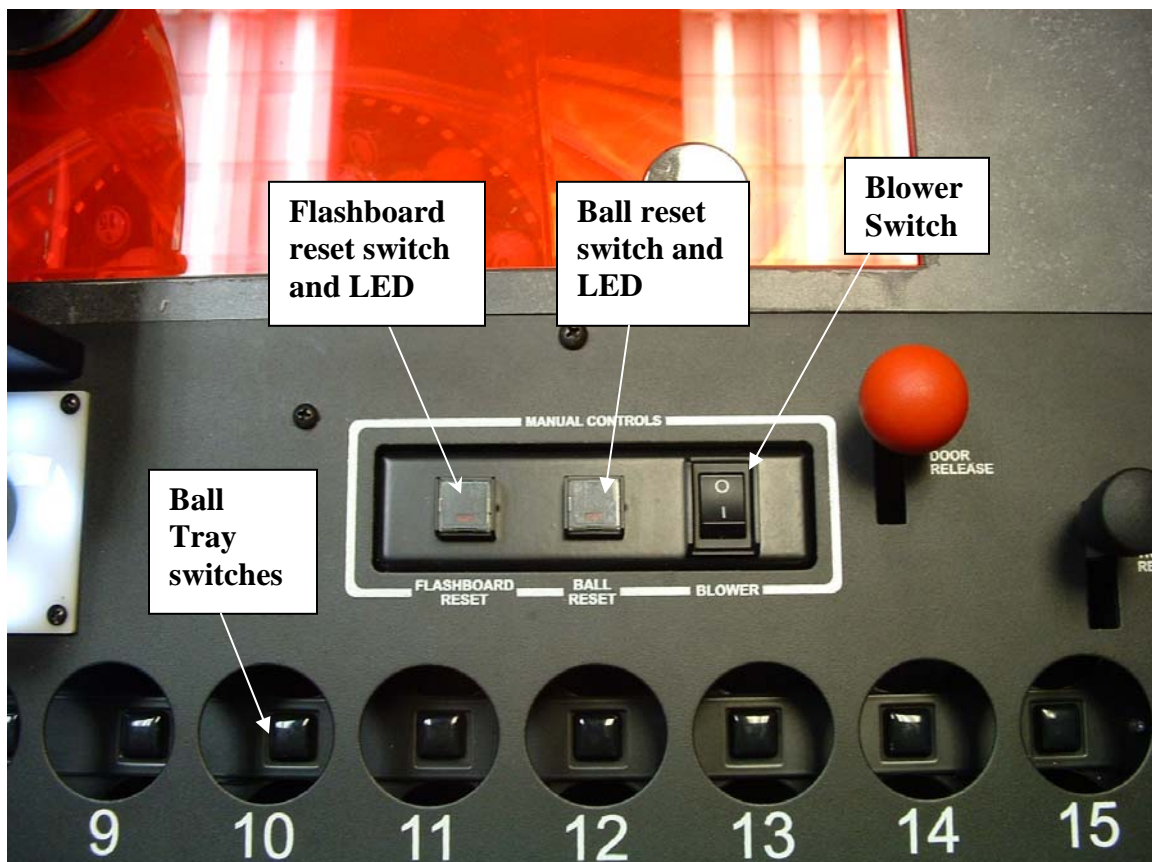

FIGURE 2.3

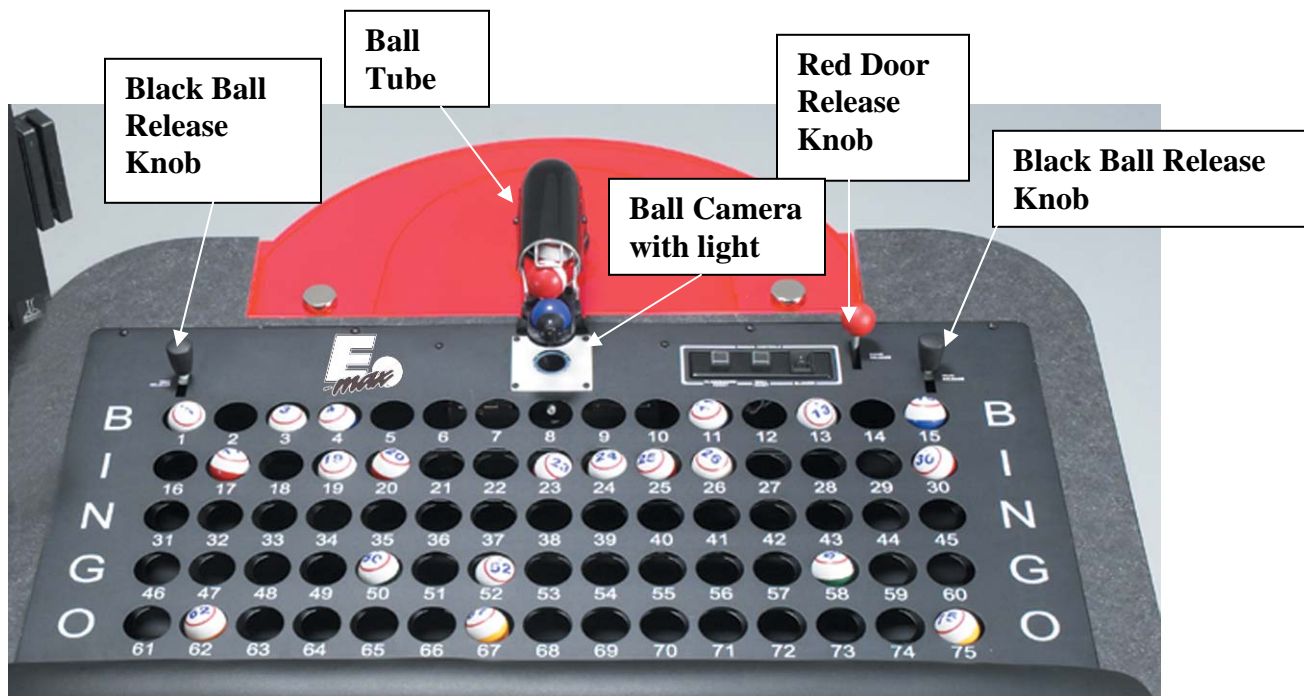

FIGURE 2.4

2.4 Electrical Installation

Refer to Appendix A for Diagrams

Connect three cables from the ball console to electronics console:

1. Plug ball console AC power cord into blower #1 socket on outlet strip #2 (Figure 2.5). If present, plug second ball console AC cord into blower #2 socket on outlet strip #2.
2. Plug in communications cable to the data router BT1 connector. Plug second communications cable into BT2.
3. Plug in camera cable into Dell computer USB5 connector. Plug in second camera into Dell USB1 connector.

NOTE: If you are installing a double blower configuration, you must configure the CPU for two ball chambers. Refer to section 11.10 for hardware setting procedure.

CONNECT UPS TO POWER SOURCE:

The main AC power input to the E-max™ Bingo Console should be 115VAC, 60Hz. The power outlet or power cord to the E-max™ Bingo Console should be wired with 12AWG or 14AWG with ground. The AC power input circuit must be rated for at least 15A and no other hall equipment should share this power source. Do not run long extension cords with inadequate wire gauge from the power source to the console.

CAUTION! A POWER SOURCE WITH ABNORMAL VOLTAGE OR EXCESSIVE NOISE CAN RESULT IN IMPROPER CONSOLE OPERATION AND POSSIBLE DAMAGE NOT COVERED UNDER WARRANTY.

1. Plug the cord from console Outlet Strip #2 (on the operator side of the electronics console) into the main power source.

E-MAX AC POWER CONNECTIONS

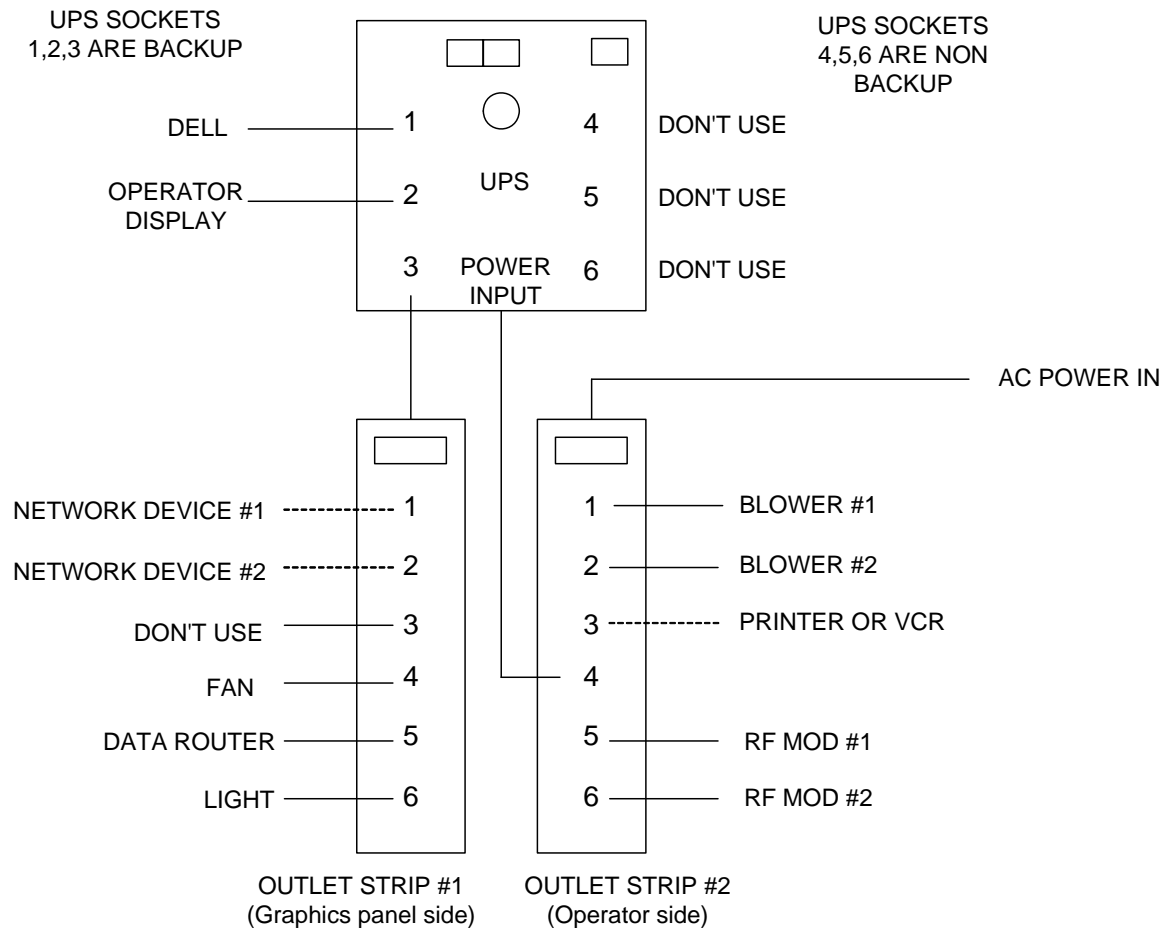

Figure 2.5

2.5 Powering up the Console

1. The main power “ON” switch for the electronic console is located on Outlet Strip #2 (Figure 2.5). After turning on, press the button on the front of the UPS (Figure 2.6).

For maximum battery backup time allow the UPS to charge for a full eight hours prior to console use.

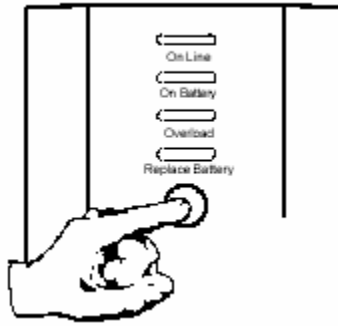

Figure 2.6

Observe that the following events occur after pressing and releasing the push-button:

- The green **On Line** indicator flashes.
- The yellow **On Battery** indicator lights while the Self-Test is being performed.
- When Self-Test has successfully completed, only the green **On Line** indicator will be lit and the Back-UPS is ready for use.

WARNING!

If the internal battery is not connected properly, the green **On Line** indicator and red **Replace Battery** indicator will light and the UPS will also emit a chirping sound. (Call for service if this occurs).

2. Once power is applied to the UPS, the red LEDs on the Flashboard Reset switch and the Ball Reset switch should be blinking. This indicates the Dell computer is off and the system is waiting for Dell communications.
3. Turn on the Dell computer by pressing the power on button on the front of the computer. The system will power up and a display will be seen on the monitor (Chapter 4). White lights on the camera ball illuminator should be on. When the Dell computer communicates with the data router and the ball tray, the two red LEDs on the manual switches will turn off.
4. Turn on the blower motor switch on the ball console. If the blower fails to start, check the blower motor troubleshooting section (**Chapter 9**). If the motor is operational, turn it off. Release the balls into the ball tray chamber by using two hands and pulling back on both black knobs. Now release the balls into the mixing chamber by pulling back on the red door release knob and holding until all balls have entered the mixing chamber.

2.6 Flashboard, Video and Audio Installation

The E-max™ Bingo Console supports a wide variety of audio, video and flashboard systems. Each installation is unique to your hall environment. Please refer to the E-max™ Bingo Console Installation Manual which describes how video, audio and flashboard systems interface to the E-max™. Your E-max™ distributor or factory representative should be consulted and assist with these installations.

3.0 Ball Handling

3.1 Handling and Calling Balls

When the blower motor is turned on, the balls momentarily mix and then 4 to 6 balls will be extracted from the mixing chamber into the ball tube. The design of the new console automatically insures that this first group of balls and all the following balls are random in nature without the need of any special pre-mixing of the balls.

The black plastic ball tube covering allows the audience to see the group of 4 to 6 balls but not pre-read the ball numbers.

The first ball extracted will come to rest at the end of the ball tube and directly over the embedded camera. The standard balls supplied with the console are double numbered. The camera views the bottom side of the ball and the operator views the top side of the ball. To adjust the ball for proper viewing on the ball monitors do the following:

1. Look at the ball, not the monitor
2. Simply rotate the ball with your fingers until the ball number is in the upright and straight position and is readable.
3. The ball will automatically appear in the correct orientation for the monitors.

*** NEW FEATURE ***

Note that the E-max™ Bingo Console requires little training for the operator compared to other bingo systems. Other systems require the operator to adjust the final position of the ball while viewing the monitor. The monitor display is a mirrored image of the ball and it takes considerable operator training to be able to adjust the ball for proper orientation. The E-max™ Bingo Console allows the operator to view and adjust the ball in a natural, intuitive manner.

3.2 Calling a Ball

1. To “call” the ball, remove the ball from the ball tube and insert the ball into its corresponding numbered hole in the ball tray.
2. Momentarily depress the ball to activate the switch associated with that ball.
3. The new console will update the operator monitor, remote monitors, and flashboard accordingly.

NOTE: Depressing the ball and activating the switch again has no effect on the system for the remainder of that game. When the system advances to the next game, the switch becomes active again.

NOTE: The E-max ball chamber uses a special antistatic mat and anti-static coated bingo balls. The anti-static properties of the E-max Bingo Console are dependant on the use of these balls. It is recommended that only the balls that are supplied with the E-max Bingo Console be used.

3.3 Resetting the Ball

If the ball was inserted in the wrong hole then:

- Remove the ball from the hole
- On the operator monitor, touch the ball number of the wrong hole. This will reset the ball and the system will be updated.
- Insert the ball in the proper hole and depress it to active the switch. The system is updated and correct.

3.4 Ball Tray System Failure

If the ball tray switches stop working, the ball should still be placed in its proper hole. The ball can be “called” by touching the ball number on the operator monitor. The system will be properly updated.

3.5 Manual Mode

1. In the event of the Dell computer fails and the operator monitor is not operational, there is a system Manual Mode that allows for only fundamental bingo operations.
2. The console is designed to automatically detect a Dell failure and switch to Manual Mode. This results in the two red LEDs on the Flashboard Reset switch and Ball Reset switch to turn on. These two switches now become active.

3.6 “Calling” a Ball in Manual Mode

1. To “call” the ball, remove the ball from the ball tube and insert the ball into its corresponding numbered hole in the ball tray.
2. Momentarily depress the ball to activate the switch associated with that ball.
3. The Flashboard will be updated.

3.7 Resetting a Ball in Manual Mode

If the ball was inserted in the wrong hole then:

- Remove the ball from the hole
- Hold down the switch in the wrong hole and then momentarily depress the Ball Reset switch.
- Release the switch in the wrong hole.

3.8 Resetting the Flashboard in Manual Mode

To advance to the next game:

- Hold the Flashboard Reset switch down for at least 2 seconds until the flashboards clear.
- All of the individual ball switches are now active again for calling new balls. All previous ball information is lost.

4.0 Console Security System

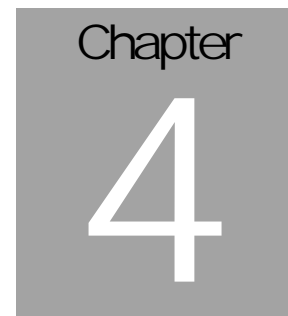

Why is there security on the E-max™ console?

Regulatory agencies and hall owners are requiring more security and tracing of system operations. Some of the items tracked by the E-max™ during gaming are:

1. Operator key stroke logs
2. Balls called and game patterns for each game
3. Winning cards for each game
4. Payouts for each game
5. Person running the console during gaming

Each of these reports can be printed or store them on a CD.

There are three levels of security on the new console system:

1. Console Operator
2. Organization/Hall Manager
3. System Administrator

Each operational feature available on the console is assigned to one or more of these levels. The System Administrator, with the highest security clearance, has access to all features, while the Game Operator has access to a more limited set of features. For some security levels, entire features or screens are disabled and not even presented to the user. In other cases, certain buttons and selections on the screen are “grayed out” or disabled.

For each user, the system stores:

1. Name
2. Password
3. Security level
4. An association of the user to one or more organizations



The last item is required since a single console may be used by several organizations. The system security can therefore be set up such that a given user is only allowed access to their related organization’s gaming schedules and set ups.

There is a screen available for entry, editing, and removal of these four user items under “Utilities”. There is also a security level associated with the entry of user data into the system:

1. There is only one System Administrator assigned to the console. The System Administrator can enter and edit user data for multiple Organizations/Hall Managers and Console Operators. They can also change the Name and Password for the System Administrator. The System Administrator automatically is associated with all organizations in the database.
2. Organization/Hall Manager can enter and edit user data for multiple Console Operators and also change their own Name and Password.

3. A Console Operator cannot change their password without an Organization/Hall manger.

The system requires a user to “Log On” to the system before access is granted. Only one user can be logged on the system at a time. Therefore, a current user must “Log Off” the system for a new user to take control of the system.

To log on to the E-max Bingo Console:

1. Slide your user Magnetic card through the reader (future Upgrade) or
2. Enter your user password
 - a. With finger touch
 - b. With mouse curser and clicks on the video keypad
 - c. With the Dell keypad
3. Touch the **ENTER** button.

Note: The Magnetic Card included with your E-max Bingo Console is the “system Key”. You must not loose this card! Keep the card in a safe place and protect it from damage. (Future Upgrade)

Initial Factory Security:

On a factory new console, a default name and password are entered into the database for a System Administrator. The loaded information will be given to the proper personnel when installing the new console. The System Administrator can log on the console to set up gaming and play games, however the system administrator must enter user data for the Organization/Hall Mangers and Console Operators before they can use the console. An E-max™ service representative or authorized distributor can provide assistance in the set up.

When assigning passwords for a Console Operator, use an easy to remember number since many volunteer operators may use their password infrequently.

Passwords are a minimum of 4 and a maximum of 10 numeric digits.

5.0 Quick Tour

Chapter

5

Quick Tour takes you through the steps required to play a simple bingo session. A preloaded bingo game called **DEMO** has been installed to help you simulate an actual bingo game. This quick tour will show you:

- ❖ How to select a bingo schedule
- ❖ Playing a bingo game
- ❖ Verifying a winner
- ❖ How to change game parameters using the toolbar
- ❖ How to cycle through sessions

NOTE:
To create your own sessions see Chapter 6

5.1 Tutorial

5.2 System Start Up

To start the quick tour program you must first apply power to the console. The system will take a few moments to boot up which will bring you to the **Login** screen (**Figure 5.0**) Slide your magnetic card through the card reader(future upgrade) or Enter your pin number and touch the **ENTER** button. The **Main Menu** Screen will appear. From this screen touch the **PLAY BINGO** button. (**Figure 5.1**)

NOTE: Use the factory supplied password 13629 when starting a new console.



Figure 5.0

5.3 Playing Bingo

After touching the **PLAY BINGO** button the **Choose Schedule** screen will appear. (Figure 5.2) This screen displays a list of preprogrammed schedules on the left, details about those schedules in the middle and serial numbers (optional) on the right. To begin the tutorial, touch the **Demo** button on the left side of the screen and then touch the **Activate** button. This will bring you back to the **Main Menu Screen**. Touch the **Play Bingo** button. This will take you to **LIVE GAME SCREEN**. **NOTE:** A schedule must be activated by a manager or system administrator before it can be played by a console operator.

Figure 5.1

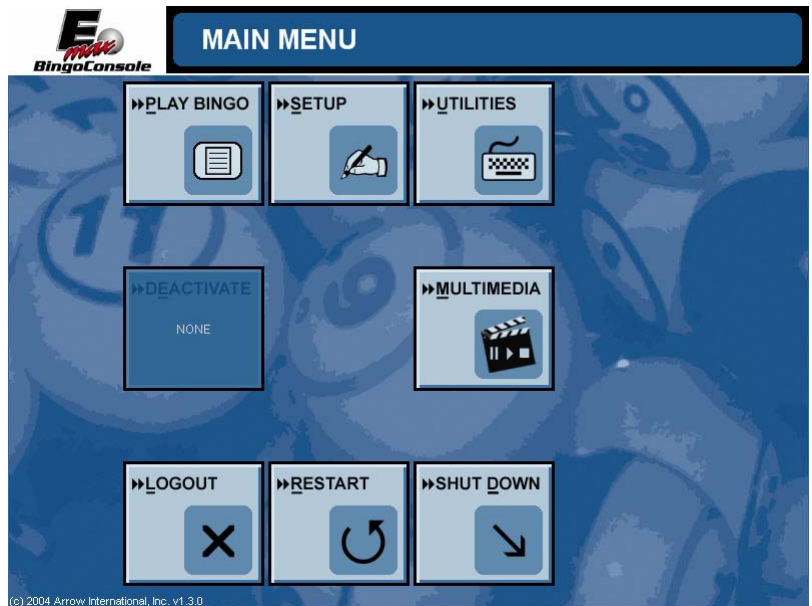
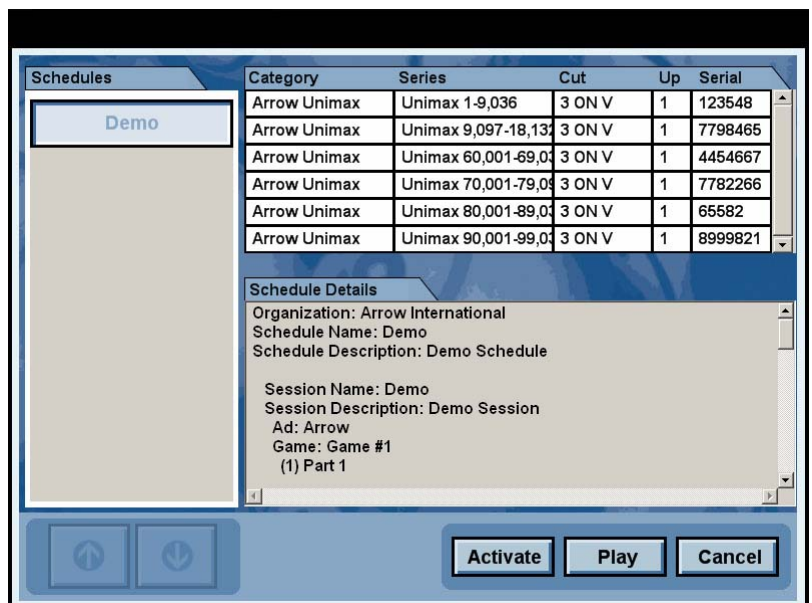

Figure 5.2



The **Live Game Screen (Figure 5.3)** is now displayed with the Demo *Schedule* as the preloaded session. There are several items that make up this screen:

- Session / Game Info Upper left corner – The first line displays the *Game #* of the current Game, Next line displays the *Part #* of the current Game, Next line displays the *Last Ball* called, then *Total Calls* in real time for current game and the last line displays the *Dollar Value* for the current game.
- Clock Display – Displays the current time and date in the upper right corner.
- Flashboard Screen – Displays the same data output as the external flashboards.
- Ball Call Timer – Displays a timer that counts down the number of seconds between ball calls.
- Current Ball Status – Displays the number of calls, the last ball called and the ball activated timer count.
- Game Pattern – Displays the current game pattern being played.
- The Live Video Window – Is shown to help the caller place and align the last ball called in the center of the hall monitor. When the game is set to the *RNG* mode a graphical representation of the last ball called is shown. This window will also display an advertisement when selected from the advertisement screen.
- Marquee –The current marquee will be displayed scrolling at the bottom of the Game Screen. Marquees can be attached when a session is built or they can be selected from the Marquee screen.
- Toolbar – The **Live Game Screen Toolbar** has buttons that can be selected during every bingo game. Each of these selections will only affect the *current game*. Any permanent changes to the session's parameters should be programmed in **SETUP** located at the **Main Menu screen**. (See *Chapter 6 System Programming – Creating a Bingo Session*)

From this screen you may now play a demo game. Turn on the **Blower Power Switch**. You will see the game pattern for the tutorial displayed on the **Live Game Screen**. Start calling balls as you would in a regular session. The ball timer will reset to a preprogrammed limit and start counting after each ball is placed into the ball tray. The timer can be manually adjusted during game play by using the **up/down arrow keys** on the touch screen or the **up/down arrow keys** on the keyboard. The next step of the tutorial will show you how to verify a winning bingo.

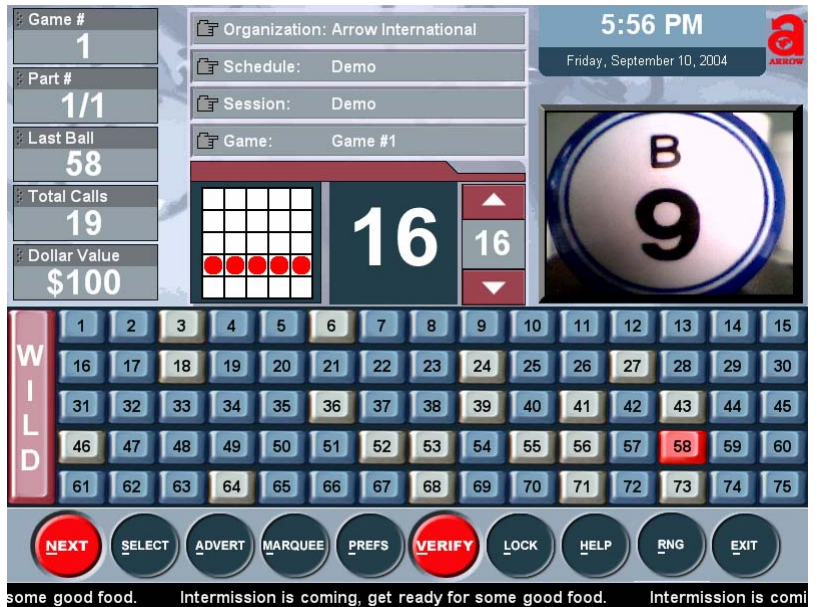

Figure 5.3

Hot Key Feature

You will notice that each selection button in the E-max™ toolbar has the first letter underlined. The E-max™ features a “hot key” function that allows the caller to select options from the touchscreen or by pressing the first letter of the option on the keyboard.



5.4 Verifying a Winner

To verify a winner, touch the **VERIFY** button located on the toolbar. This will bring up the **Enter New Card (Figure 5.4)** screen.

NOTE: (Optional AUTO SEARCH FEATURE) the paper categories for the session being played will appear on the top of the category list and will not have parenthesis around them. If more than one category is programmed for a bingo session the **E-max™** will perform an **auto search** of all the programmed categories in order to determine a valid winner.



Figure 5.4

If you are playing a different category of paper from the one that is programmed, you can choose a **Category** on the left side of the screen to specify the perm you wish to verify. Next enter the card number then touch **Enter**.

The **Verify / Payout** screen is now displayed (Figure 5.5). **Winner (Figure 5.6)** or **Not a Winner** will be displayed on the lower left portion of the card with the last ball number flashing. By touching the **NEXT** button you may enter in another card number to verify. By touching the **CHANGE** button you may change the dollar value for the selected winning payout.



Figure 5.5

Touching the **SAVE** button will save the payouts and take you back to the **Live Game Screen** for the current game. Touching the **DONE** button will save the payouts for the current game and take you to the next game or next part of the current game. The **CANCEL** button will cancel any payouts you have input and take you back to the **Live Game Screen**.

The Verify/Payout screen allows you to quickly verify winning cards for your bingo session. You can verify multiple winners, calculate the payout and remove the winning cards from progressive games.

The Serial number window on the right hand side of the screen allows you to enter the serial numbers of the books sold for your session. This adds another dimension to your games security and integrity.

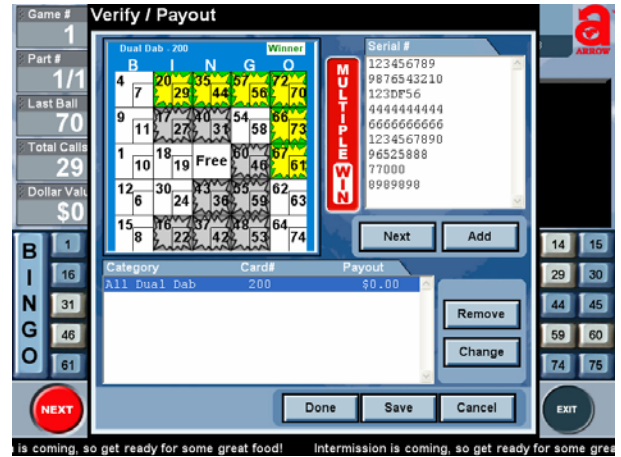

Figure 5.6

NOTE: If no valid winner is detected, the payout screen will display the first card type with the entered free space number.

5.5 Using the Toolbar

The system **Toolbar** located at the bottom of the **Live Game Screen** allows you to change games, advertisements, marquees and caller preferences. First, let's navigate to a new game in this schedule.

Touching the **NEXT** on the toolbar will move you forward to the next game or the next part of the current game. The **NEXT** button will become disabled when you reach the last part of the last game in the schedule.

Touch the **SELECT** button on the **Live Game Screen**. This will bring up the **Game Selection** screen. This screen is a scrollable list of all the games in the schedule. The current game being played is displayed at the top of the screen. To change the current game, scroll the game you wish to play using the arrow buttons at the bottom of the screen, and select the desired game from the list. (Figure 5.7)



Figure 5.7

The **ADVERT** button brings up the **Advertisements** screen where you can select an advertisement to be played immediately. (Figure 5.8). The advertisement will be displayed on the **Live Video Window** in real time when the **SEND** button is touched. (To add advertisements see Chapter 6 System Programming)

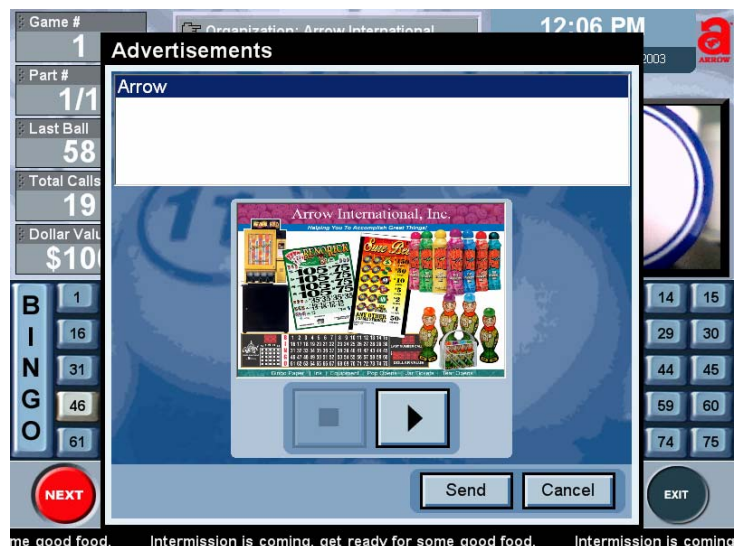

Figure 5.8

The **MARQUEE** button brings up the **Marquee Screen (Figure 5.9)**. From the **Marquee Screen**, you can select an existing marquee, add a new marquee, edit an existing marquee or delete a marquee.

Existing messages are shown in the list at the top of the screen. The lower list is the list of marquee messages that are currently playing. To play a message, select it from the existing message list and touch the down arrow to move it to the currently playing list.

You do have the option of adding multiply marquees to the **Live Video Window** by simply adding as many as you like to the currently playing list.

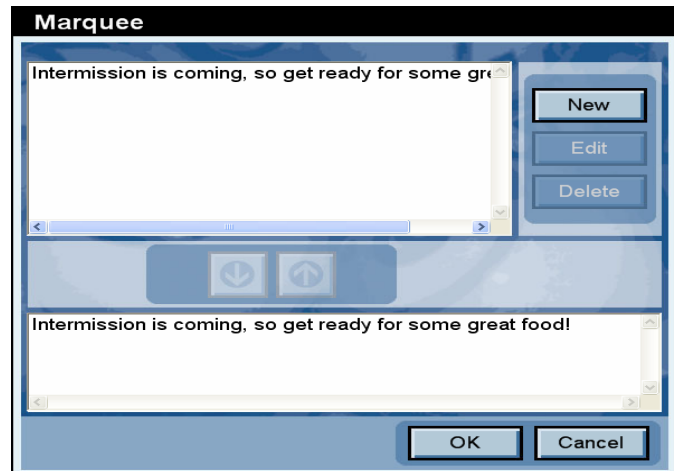

Figure 5.9

To stop a message that is currently playing, select the message in the currently playing list and touch the up arrow to remove it.

Touching the **OK** button will accept any changes you have made. Messages added to the currently playing list will start scrolling, and any removed from the list will be removed from the scrolling marquee.

To add a new marquee, touch the **NEW** button, and enter your new message on the Keyboard screen. Touch the **OK** button to add the new marquee. To edit an existing marquee, touch the marquee you wish to edit. Next touch the **EDIT** button which will bring up the **Keyboard** screen. You may edit your marquee then touch **OK** to save your new marquee message. To delete a message, select it in the list, and touch the **DELETE** button.

The **PREFS** button brings up the **Preferences (Figure 5.10)** screen. Five choices are displayed on the right of the screen. You can make changes to audio volume by touching **VOLUME**, to the game itself by touching **CALLERS CHOICE**; to the way external flashboards are set up by touching **FLASHBOARD**; if you have a double blower you can change which ball camera will display by touching **Camera Settings** and you can display an external video source on your hall monitors by touching **Video**.



Figure 5.10

The **VOLUME** page will allow the user to choose one of five speaker output volumes ranging from **VERY LOUD** to **MUTE**.

The **CALLERS CHOICE** page allows you to change bingo options for the current game before the game starts. Once the first ball has been called, the game options can not be changed. (**These options are discussed in chapter 6, System Programming**)

The **Flashboard** page allows you to changed Flashboard output (**Game Pattern Numeric and Dollar Value Numeric**) for the current game automatically by selecting them from the drop down list box and touching the **OK** button (**Figure 5.11**).

You can also disable the flashboard for the current game by placing a check mark in the **Disable Flashboard** box.

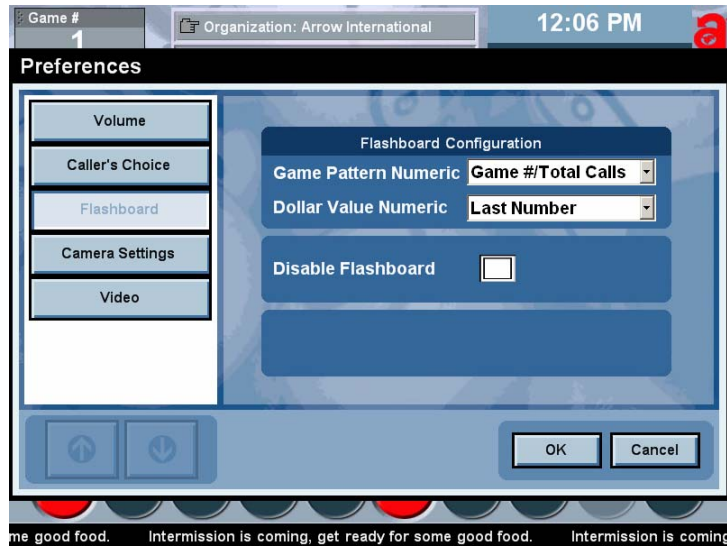

Figure 5.11

The **Camera settings** button is used in a double blower configuration. This feature allows the caller to switch between the bingo camera and the tear open camera. (**Figure 5.12**)

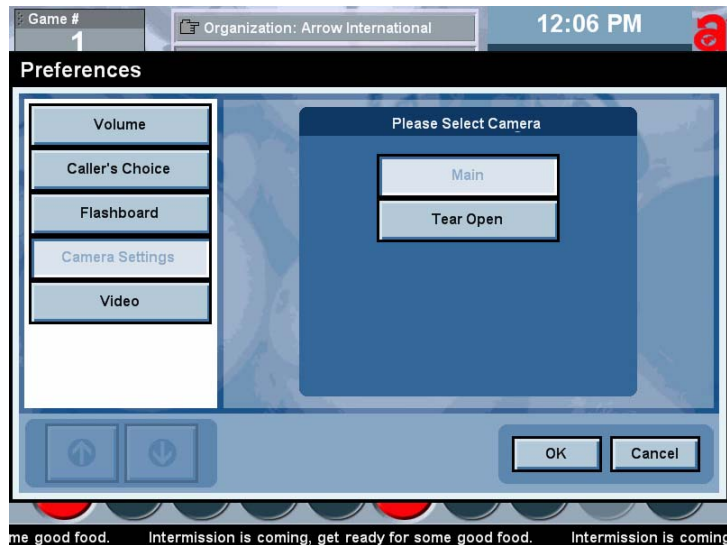

Figure 5.12

The **VIDEO** Screen (**Figure 5.13**) allows you to send an external video source (such as a DVD, VCR or Cable TV) to the halls external monitors.

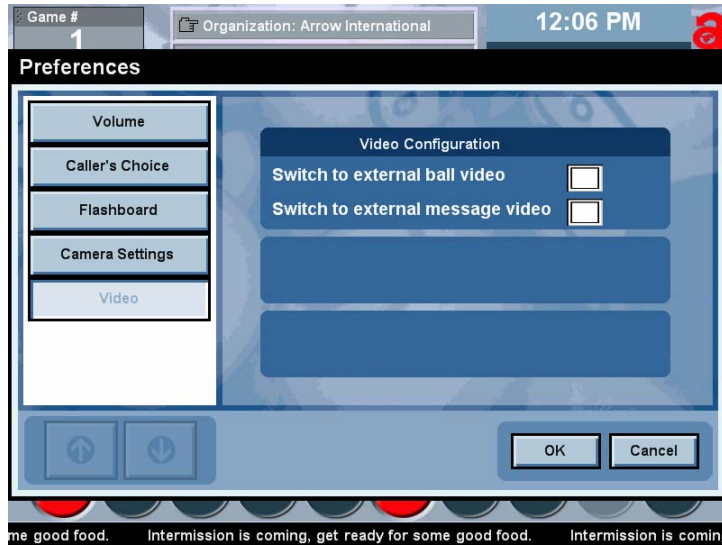

Figure 5.13

Touching the **HELP** button brings up the electronic copy of this manual (**Figure 5.14**). The manual is hyperlinked and indexed for quick reference.

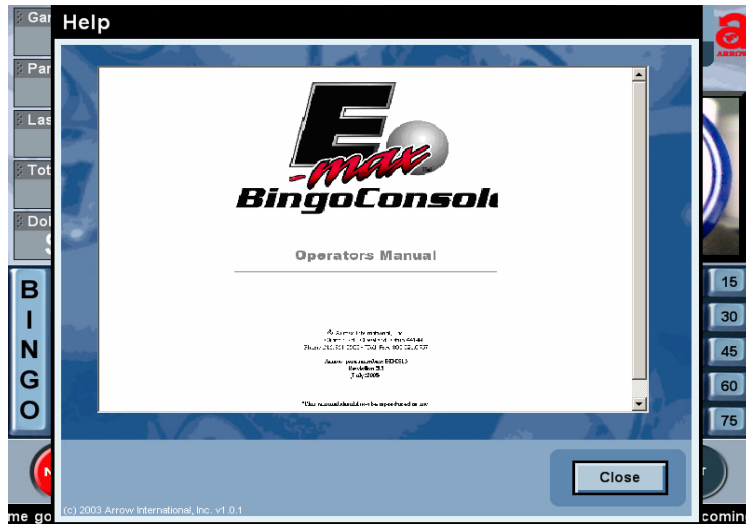

Figure 5.14

6.0 System Programming

Chapter

6

This chapter covers the E-max™ Bingo Console programming and advanced features.

6.1 Creating and Editing a Bingo Session

To create bingo session(s) touch the **SETUP** button from the **Main Menu** (Figure 6.0). The **Organizations** screen is displayed (Figure 6.1)



Figure 6.0



Figure 6.1

From the **Organization** Screen you can **EDIT** an existing organization (if present) or you can create a new organization by touching the **NEW** button. This will display the keyboard screen. From the keyboard screen type in a new organization name you wish to create by touchscreen or keyboard. (Figure 6.2)



Figure 6.2

The following demo session will explain the tabs and the settings in those tabs. In this demo session we will examine the Arrow Organization and then step through each setting. Touch **Arrow International** in the **Organizations table**. This will select **Arrow International** and fill in the default settings as shown in **Figure 6.3**.

In the **Settings** area of the organizations screen are several default settings that can be changed (**Figure 6.3**). Touch the **EDIT** button to edit settings. Touch the **SAVE** button to save changes when finished.

The **Verification** drop down list box displays **No Last Ball** and **Last Ball Required**. This allows you to select the verification method for all games in the organization. The **Marquee** scrolling speed can be adjusted from **slow** to **medium** to **fast**.

The **Number Parts** box when enabled (check mark in box) will increment the session game #'s whenever a new part is created. This feature allows the creation of progressive or multiple part games.

The **RNG** (*Random Number Generator*) feature must be installed by maintenance personnel before it can be activated. This feature can be disabled (shaded out) from the Operator's Console Playing Bingo screen by leaving the selection box blank. Placing a check mark in the **RNG** box allows you to select Random Number Generator during a bingo game from the Operator's Console Screen.

The **Caller's Choice** feature must be installed by maintenance personnel before it can be activated. When selected (*check mark in box*), the **Caller's Choice** option from **PREFS** (Preferences) menu on the **Operator's Console Playing Bingo Screen** will be enabled. To disable the **Caller's Choice** option, un-check the **Caller's Choice** box.

To display the marquee in the Camera monitor place a check mark in the **Show Marquee** box by the **Camera Monitor**. To turn off the marquee in the **Camera Monitor** uncheck the box. To show the marquee in the **Message Monitor** place a check mark in the **Show Marquee** box by the **Message Monitor**. Uncheck the **Show Marquee** box to turn off the marquee from displaying in the message monitor.

To display advertisements on the Message Monitor select **ADVERT** from the **Message Monitor** drop down box. To display the flashboard on the **Message Monitor**, select **FLASHBOARD** from the **Message Monitor** drop down box.

Depending on the type of Flashboard you are using, **GAME PATTERN NUMERIC** or **DOLLAR VALUE NUMERIC**, you can change the output values by selecting the drop down box of each. This selection will output the selected value to your flashboard if it supports the display value you selected.



Figure 6.3

To create a schedule(s) touch the **Schedules** tab.

The **Schedules** screen is now displayed (**Figure 6.4**).

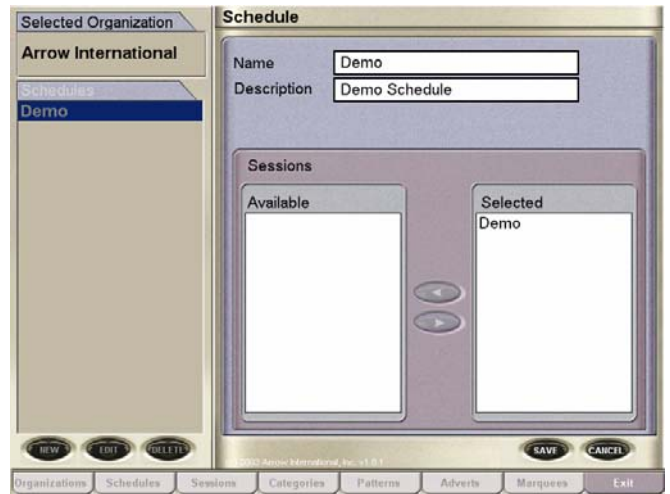

Figure 6.4

To create a new schedule, touch the **NEW** button and type in *Arrow Schedule* in the Schedule Name Screen and touch the **OK** button.

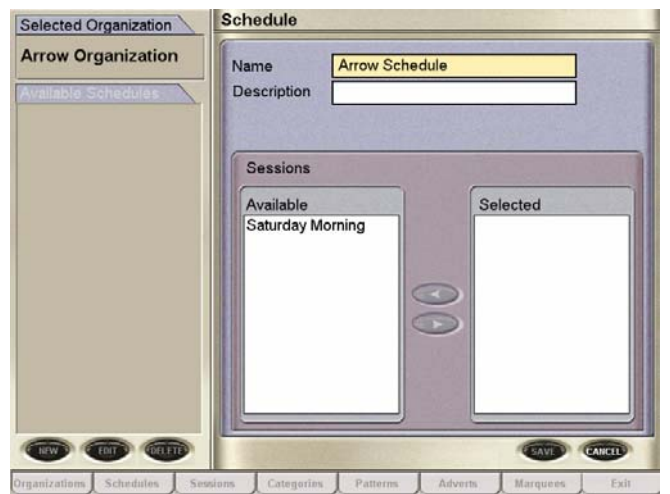

Figure 6.5

To select the previously loaded Quick Tour session Demo, touch it then touch the right arrow button and touch **SAVE**. This will move the Demo session to the available sessions for *Arrow International Organization* (**Figure 6.5**).

To edit and or create new sessions touch the Sessions tab (**Figure 6.6**). This will display the Sessions screen. In the sessions screen you can create a new session, edit an existing session or delete a session.

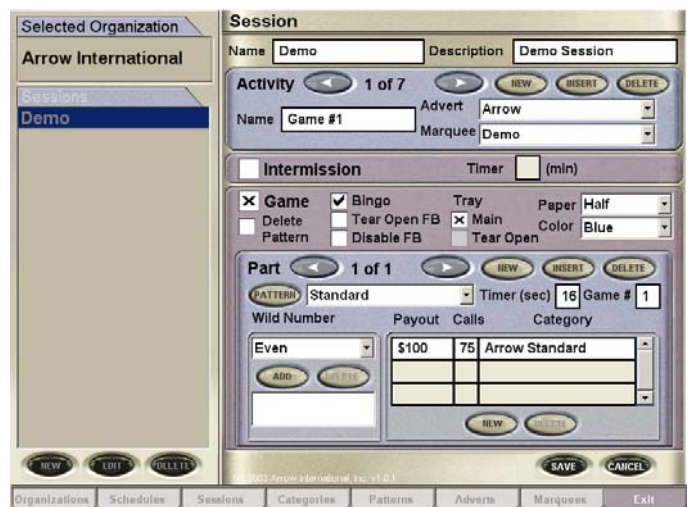

Figure 6.6

Under the Sessions screen on the left displays your selected organization and all available sessions associated with that organization. The Quick Tour Demo is displayed in (Figure 6.6) with previously loaded settings.

To create a new session, touch the **NEW** button. The **SESSION NAME** screen now appears. Next, type “Saturday Afternoon” in the **SESSION NAME** field. Since all new sessions **MUST** have an activity associated with it, type in Early Birds in the Activity field. This will create a new activity called *Activity1* with default settings shown in (Figure 6.6). Use the drop down box at the right of the **Advert** and **Marquee** to add an **Advert** or **Marquee** to *Activity1*. Since all new activities are by default **Game** activities, the **Game** checkbox is selected. Touch the **SAVE** button at the bottom of the **Sessions** Screen to save *Saturday Afternoon* (Figure 6.7).

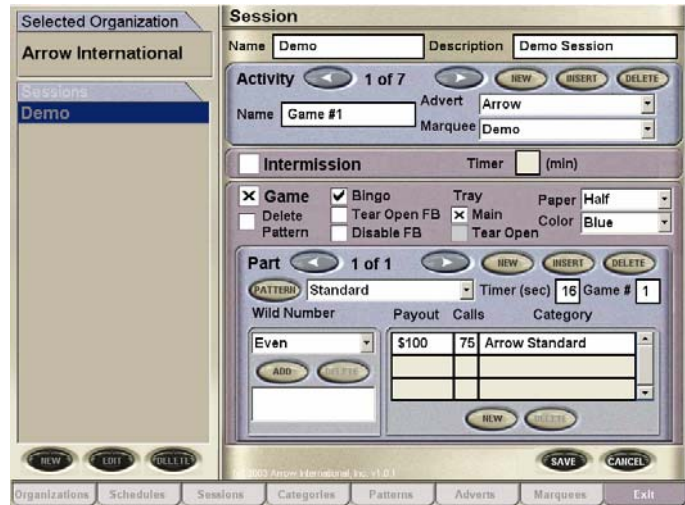

Figure 6.7

We will now step through and edit the Saturday Afternoon session. Touch the **EDIT** button to edit *Saturday Afternoon* session *Activity1* game settings (Figure 6.8). Currently, Saturday Afternoon has one activity called Early Birds, to create additional activities for *Saturday Afternoon* session select the **NEW** button in the Activity panel. This allows you to add new activities in sequence. To insert a new Activity, touch the **INSERT** button, this will insert an activity before your active activity shown. To delete the currently selected activity, touch the **DELETE** button to delete the current activity. To change the activity from a **Game** to an **Intermission**, place an **X** in **Intermission** box. A **Timer** box (in minutes) allows you to define the amount of minutes the intermission will run for.

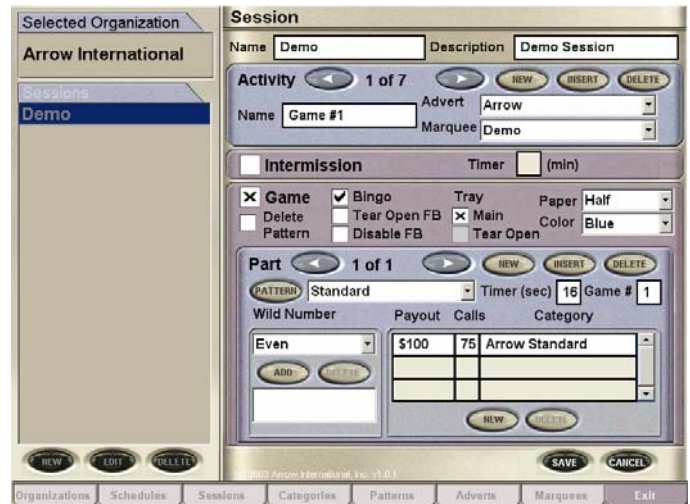

Figure 6.8

For *Activity1* the **Game** panel area has several settings that we will cover now. The **Delete Pattern** check box when checked enables you to play delete pattern games on the console. The **Bingo** and **Tear Open** checkbox’s enables you to select the output of that game to a Bingo Flashboard or Tear Open or even both.

The **Tray** checkbox’s, **Main** and **Tear Open**, are enabled only when you are using multiple ball trays. If you have a configuration of two ball tray’s attached to your electronic console, the **Main** and **Tear Open** checkbox’s enables you to select which ball tray you will be using for your selected game. The Tray’s **Main** and **Tear Open** selection also affect what camera will be operational for that game.

The **Paper** drop down box contains selections on how the cards will be displayed out to the monitor.

The **Color** drop down box will define color of face cards that you will be using for the selected activity.

The **Pattern** drop down box will define the pattern that you will be using for the selected activity.

NOTE: To see the pattern as it will appear on the flashboard, touch the **Pattern** Button. When you are finished, touch the **Close** button on the preview window.

The **Part** Panel displays the number of parts associated with the selected session. You may cycle through Parts by touching the left and right arrow keys. To add a new part, touch the **NEW** button.

To insert a new **Part** touch the **INSERT** button, this will insert a part in between your selected **Part** showing. To delete a **Part** touch the **DELETE** button, this will delete the select Part showing on the screen. To select a different pattern for a selected **Part** touch the **Pattern** drop down list box and select it from the list. Touch the pattern Button to preview the selected pattern.

To select a different time for the Ball Timer touch the number in the **Timer (Sec)** box which will bring up the Ball Timer keypad where you can enter the new time and touch the **OK** button to save it.

To select a different **Game #** (Play Number) for a particular Part touch the **Game** number and enter in the new Play Number and touch **OK** to save.

The **Wild Number** can be changed for a particular **Part** by selecting the drop down list box under **Wild Number**. Touch the **ADD** to add more than one **Wild Number** to a Part. Touch the **DELETE** button to delete the selected **Wild Number** for the selected Part.

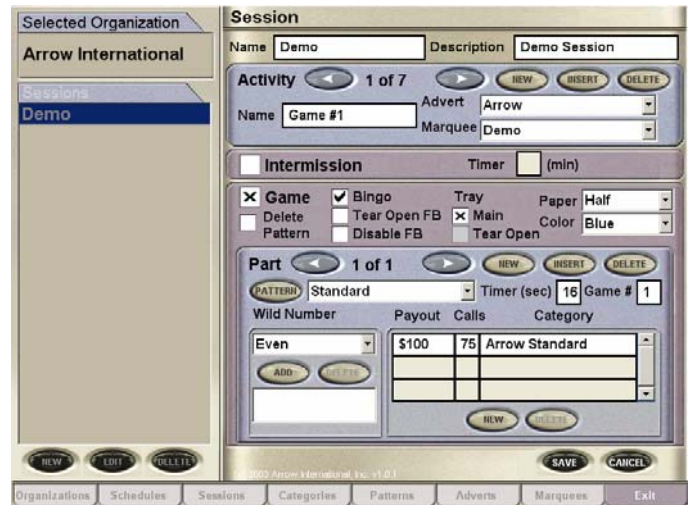

Figure 6.9

To add more payouts for a particular Part touch the **NEW** button at the bottom of the payout section and enter in new **Value Payout** number then touch **OK**. To delete a payout touch the payout category you wish to delete then touch the **DELETE** button.

The **Categories** tab (**Figure 6.10**) defines the card types; series; cuts and ups associated with them. To add a new category touch the **Categories** tab. The categories tab list the categories on the left then name, description and the card type for that selected category.

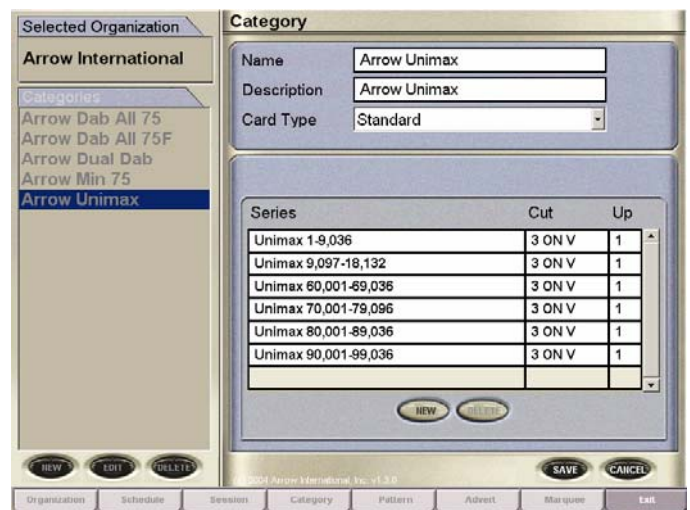

Figure 6.10

To change the **Card Type** for a selected category, touch the **EDIT** button and then touch the **Card Type** Arrow key. The different card types will appear in a drop down menu. Select the card type by touching it. The series window will clear and allow you to add the desired series. Touch the **New** button, Touch **OK**, touch the desired slot located in the **series** window. This will bring up a drop down menu that lists the card type and series available. Touch the desired card type and series to select it. Next, touch the cut window to select the cut of your bingo paper. Now you can touch the up window to select the number of sheets in your paper package.

These new features allow for even more security and integrity to your players gaming experience. To save category and card type selections touch the **SAVE** button at the bottom right of the categories window.

To create a new Category, touch the **New** button. This will bring up the **Keyboard screen**. Type in the name of your new category and touch the **OK** button. After you have named your new category

To delete a category select the category you wish to delete from the categories list on the left then touch the **DELETE** button.

6.2 Game Pattern Definitions

The **Pattern Screen** in (**Figure 6.11**) allows you to define pattern types. A catalog list of patterns is displayed on the left of the screen. The name of the highlighted pattern and its description is displayed in the **Name** and **Description** fields. The pattern itself is shown in the pattern area below the name and description fields. The Number of Combinations for the selected pattern will be displayed to the right of the selected pattern area. In **Figure 6.11** the pattern (**Standard**) is displayed with its 12 number of combinations.

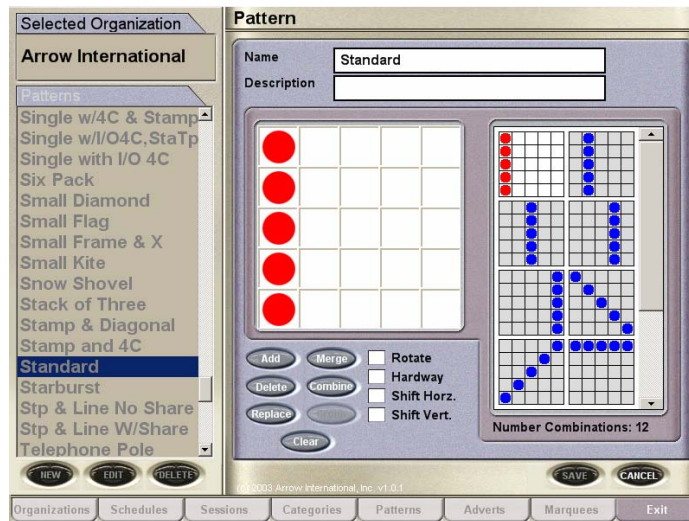

Figure 6.11

Touching – patterns are next to but do not share any cells.

Any Line with Block of 4.

O				
	O			
		O		
O	O		O	
O	O			O

Sharing – share one and only one cell between patterns.

Any Line with Block of 4.

O				
	O			
		O		
		O	O	
		O	O	O

Overlap – must share two or more cells between patterns.

Any Line with Block of 4.

O				
	O			
		O	O	
		O	O	
				O

Separate – have one or more cells between patterns.

Any Line with Block of 4.

			O	
			O	
			O	
O	O		O	
O	O		O	

Options:

Touch – True
 Share – False
 Overlap – False

Definition: Patterns must be next to but do not share any cells.

Touch – False
 Share – True
 Overlap – False

Definition: Patterns must share one and only one cell between patterns.

Touch – False
 Share – False
 Overlap – True

Definition: Patterns must share two or more cells between patterns.

Touch – True
 Share – True
 Overlap – False

Definition: Patterns that are next to but do not share any cells and patterns that share one and only one cell.

Touch – True
 Share – False
 Overlap – True

Definition: Patterns that are next to but do not share any cells and patterns that share two or more cells.

Touch – False
Share – True
Overlap – True

Definition: Patterns that share one or more cells.

Touch – False
Share – False
Overlap – False

Definition: Patterns with one or more cells are between patterns.

There are 214 preprogrammed patterns included with your E-max™ Bingo Console. You can use these patterns or create your own. You can also combine any number of programmed patterns to create multiple bingo patterns.

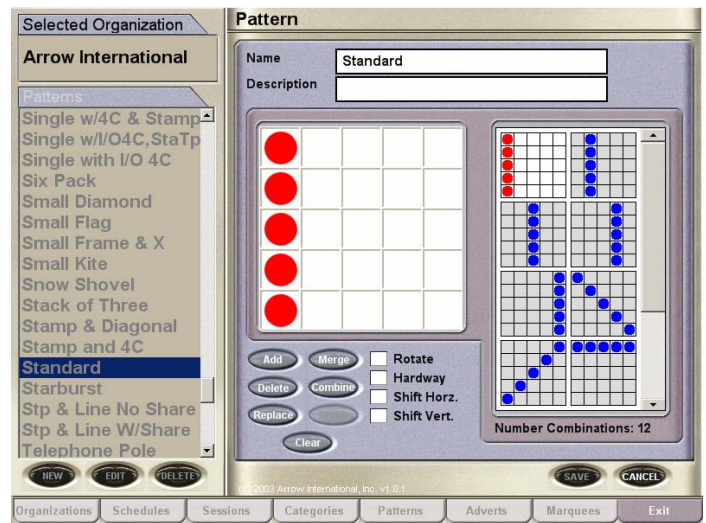

Figure 6.12

Special Functions

Chapter 7

This chapter will take you through the steps to use the E-max™ System special gaming features. In this chapter you will learn about:

- ❖ Calling wild numbers
- ❖ E-max Multimedia Functions

7.0 Wild Number Feature

The following wild number options are available to select from:

- **EVEN** – All even numbers will be called.
- **ODD** – All odd numbers will be called.
- **Trailing Number** – Any number ending with that number will be called.
- **Leading Number** – Any number beginning with that number will be called.
- **Day-** All odd or all even numbers will be called based on the calendar date.
- **Double Reverse-** Calls the reverse of the last number called.
- **Even/Odd Ball-** Calls Odd or Even balls based on the first ball called

1. Touch the **SETUP** button from the **Main Menu**.
2. Touch the desired Organization from the **Organization** Screen.
3. Touch the **Sessions** tab.
4. Touch your desired **Session** from the list of available sessions.
5. Touch the **EDIT** button.
6. Touch the **Wild Number** drop down list box from the **PART** area.
7. Select the desired Wild Number and touch the **ADD** button. This will place the selected Wild Number in the Wild Number list box (see **Figure 7.0**)

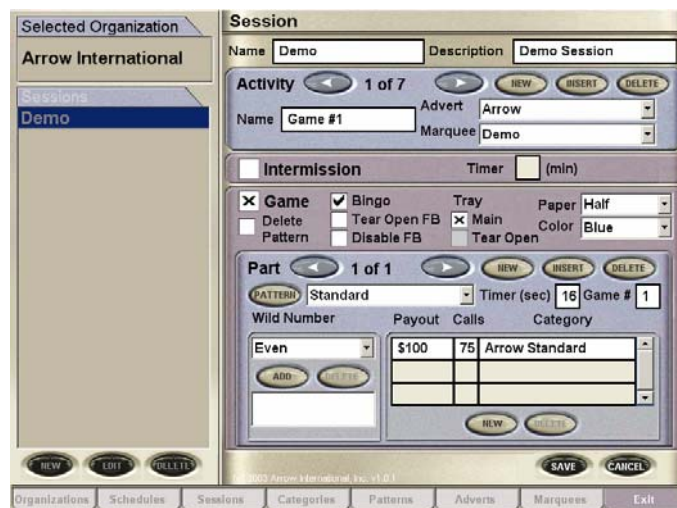

Figure 7.0

7.1 Multimedia Functions

The following options are available to select from:

- **External Video- Provides switching for VCR/DVD.**
- **Power Point – Runs Microsoft PowerPoint™ Presentations.**
- **Macro Media – Runs full Audio/Video Flash Presentations.**

Touch the **Multi Media** button from the **Main Menu** screen. This will bring up the Multimedia Options screen. (Figure 7.1)

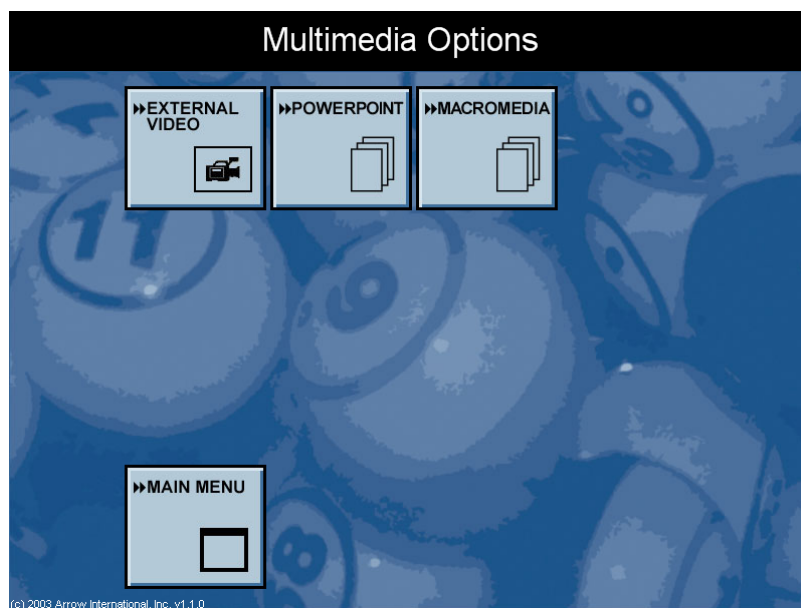

Figure 7.1

7.2 External Video

This section will take you through the steps to use the External Video feature. To Play Videos or DVD's from an external source you must first install the device. Refer to the appendix of this manual for installation information.

Once you have your player installed, follow the procedures listed below:

1. From the **Multi Media Options Screen**, touch the External Video button. This will bring up **External Video Window**. (Figure 7.2)
2. Select the monitor (monitors) on which you wish to display the video by touching the check boxes and then the “ok” button.
3. Press the play button on your device.

NOTE: To stop the video, press the stop button on your device and return to the External Video window. Deselect the monitor outputs and touch OK. This will return the video outputs to their normal settings.

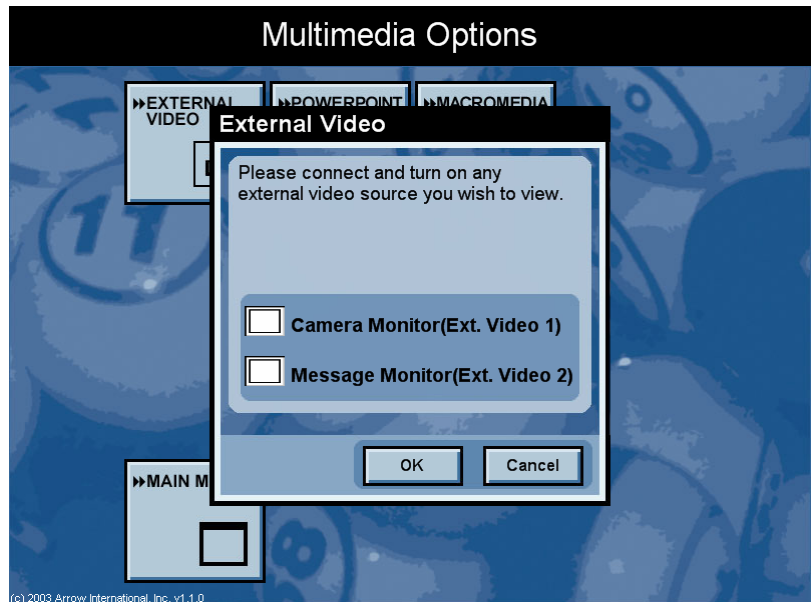

Figure 7.2

7.3 Power Point Presentations

The E-max Bingo Console can run Microsoft® Power point presentations in either .PPT or .PPS files. To run a power point presentation; follow the procedure below:

1. Insert your CD into the DVD (top) drive of the Dell CPU.
2. From the **Multi Media Options Screen**, touch the **Power Point** button. This will bring up the Power point window. (Figure 7.3)



Figure 7.3

NOTE: This may take several minutes depending on the size of the files.

3. Select the presentation you wish to run from the list of files displayed in the window.
4. The **Message Monitor** is the default monitor for the presentation and cannot be changed. You can select the **camera monitor** if you wish to use it.
5. Touch the **Play** button to start the power point presentation.
6. Touch the **stop** button to stop the presentation
7. To exit the power point window, touch the **close** button.

NOTE: Files with the .PPS extension will run as timed slide shows while files with .PPT extension can be run manually by using the up and down arrow keys on the keyboard. At the end of the show, the Power Point options window reappears on the callers monitor.

7.4 Macro Media Presentations

The E-max Bingo Console can run macromedia® Flash Media presentations in .SWF files. To run a Macro Media presentation; follow the procedure below:

Insert your CD into the DVD (top) drive of the Dell CPU.

From the **Multi Media Options Screen**, touch the **Macro Media** button. This will bring up the **Macromedia Flash** window. (Figure 7.4)

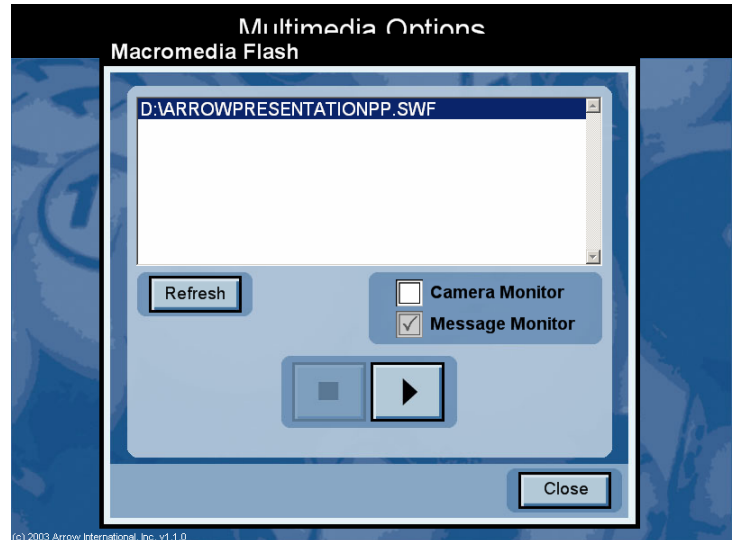

Figure 7.4

NOTE: This may take several minutes depending on the size of the files.

1. Select the presentation you wish to run from the list of files displayed in the window.
2. The **Message Monitor** is the default monitor for the presentation and cannot be turned off. You can select the **Camera Monitor** if you wish to use it.
3. Touch the **Play** button to start the presentation
4. To stop the presentation, touch the **stop** button
5. To exit the macromedia flash window, touch the **close** button

NOTE: To exit the Multimedia Options screen; close the current window and touch the Main Menu button on the Multimedia Options screen.

7.5 Playing Videos during a Session

The E-max Bingo Console can play videos/ DVD's during an active gaming session. To do this; follow the procedure below:

1. Insert your media (VHS tape/ DVD) into your player.
2. Press Play on your device
3. On the **Live Game Screen**, touch the **Prefs** button. This will bring up the caller preferences screen. (**figure 7.5**)
4. Touch the **video** button. This will bring up the video configuration screen.
5. Select the monitors that you wish to display the video on by touching the appropriate check box and then touch **OK**.

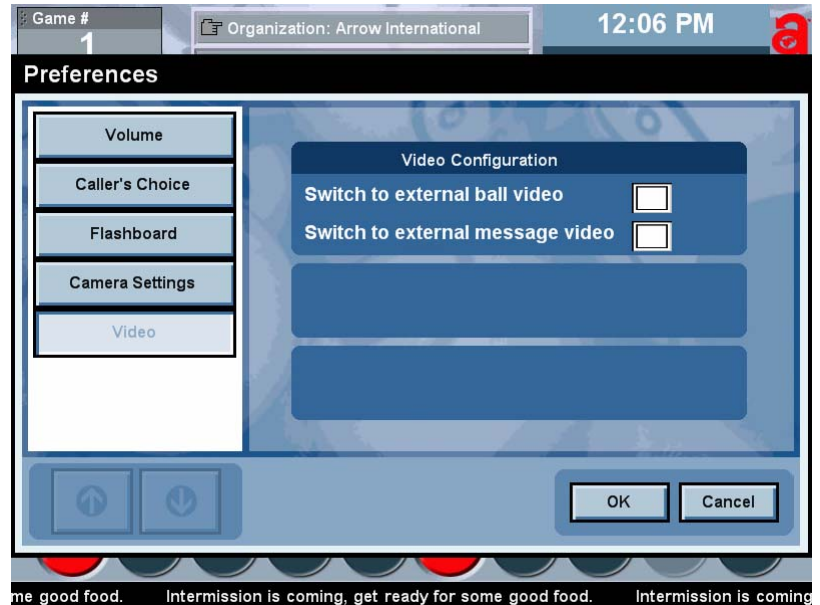

Figure 7.5

NOTE: to stop the video you must press the stop button on your device and return to this screen and uncheck the monitors then touch OK.

7.6 Recording a Session

The E-max Bingo Console can record an active gaming session with the (optional) VCR installed. To do this; follow the procedure below:

1. Insert your media (VHS tape into your player).
2. Press **REC** on the VCR
3. Play your Session

4. To View the recorded Session, go to the **Live Game Screen**, touch the **Prefs** button. This will bring up the caller preferences screen. (**figure 7.6**)
5. Touch the **video** button. This will bring up the video configuration screen.
6. Select the monitors that you wish to display the video on by touching the appropriate check box and then touch **OK**.

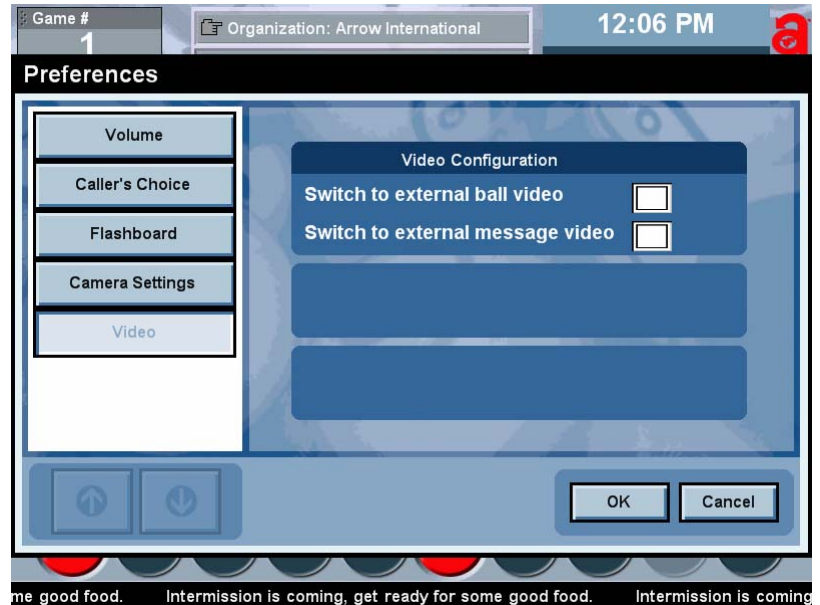

Figure 7.6

NOTE: Your VCR is factory preset to work with the E-max™ Bingo Console. During shut down or power failure the VCR may lose the setting memory. If this happens, set the VCR channel to **channel 4** and set the video input to **LINE 1**. Please refer to the owner's manual of the VCR for further information about the operation and care of the VCR.

CAUTION! THE CONSOLE SYSTEM MUST BE POWERED DOWN WITH THE UPS SWITCH BEFORE SWITCHING OFF OUTLET STRIP #2. FAILURE TO SHUT THE UPS SYSTEM OFF FIRST WILL RESULT IN INCOMPLETE UPS BATTERY DISCHARGE AND PREMATURE BATTERY FAILURE NOT COVERED UNDER WARRANTY.

8.0 Servicing and Cleaning

Chapter

8

8.1 General Cleaning of Your E-max™ Bingo Console

Periodic servicing of your bingo equipment should include cleaning, polishing, and light bulb replacement. Doing so will prolong the life of the equipment, increase trade in value, and reduce breakdowns. Recommended cleaning agents and methods for the console and flashboard are as follows:

Monitor Touch Screen

Pour rubbing alcohol on a clean soft cloth and gently rub the screen to remove greasy finger prints. **CAUTION:** Do not pour alcohol, water or any other liquid directly on the screen.

Console Painted Metal Surface

Use a mild soap solution or mild cleanser on a soft cloth. Harsh cleansers or solvents may damage the paint or lettering. Follow with an automotive style polish for additional protection. **CAUTION:** Do not pour alcohol, water or any other liquid directly on the surface.

Console Laminate Panels

Use a mild soap solution or Kitchen style cleaner on a soft cloth. Harsh cleaners or solvents may damage the laminate surface.

Console and Flashboard Acrylic Surfaces

Use only a mild soap solution such as a liquid detergent solution on a clean soft cloth. Do not use solvents, aromatic spirits, mild cleansers or paper towels since they may scratch the surface. **CAUTION:** Do not pour alcohol, water or any other liquid directly on the surface.

Camera Lens

Use a vacuum cleaner to remove major dust and debris. Use a soft cloth to wipe lens.

Bingo Balls

Clean with a soft cloth and mild soap solution such as a liquid detergent and warm water (not hot water) or a solution of 25% rubbing alcohol and 75% warm water. Harsh cleansers or solvents may damage the finish or lettering. Dry the balls thoroughly using a cloth towel. Do not submerge the balls in liquids or use automatic washing machines.

8.2 Replacing the Graphics Panel Lamp

HARZARD! Before replacing the light, turn off the switch on outlet strip #1.

The Graphics Panel fluorescent light is located just inside the electronic console above the graphics panel door. Remove the Light fixture from the console and gently squeeze the diffuser lens to remove it from the fixture. The fluorescent lamp should be replaced with the lamp specified in Appendix B.

8.3 Replacing the Blower Air Filter

CAUTION! Insure that the ball console power switch for the blower motor is in the off position before servicing the filter.

The air filter is located in the Ball Console behind the access panel (**Figure 8.0**) Unscrew the two turn button screws on each side of the access panel to remove the access panel. Slide each air filter locking retainer away from the filter then pull filter up to remove. Air filter should be replaced with the filter specified in Appendix B. Air filter replacement interval varies depending on hall air conditions and number of hours played. Check filter once a month. A dirty filter can cause motor overheating and poor ball action.



Figure 8.0

8.4 Replacing the Arm Rest

Call for Service to replace Arm Rest.

8.5 Cleaning Ball Tray Chamber

Call your authorized E-max™ distributor for all ball chamber maintenance

FOR ALL OTHER SERVICE NEEDS CONTACT YOUR LOCAL DISTRIBUTOR OR E-max™ REPRESENTATIVE.

9.0 Troubleshooting and Diagnostics

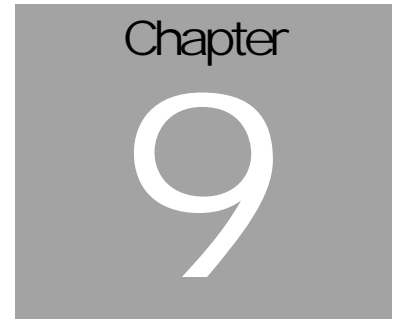

HAZARD!

Note that when trouble shooting electrical systems, be aware of the potential dangers of coming in contact with 120VAC line voltages. Use caution when handling AC power cords and devices. When feasible, during the trouble shooting procedure, turn off the AC power input when handling these devices if you are concerned with safety or call your service personnel for assistance.

When working with fuses or circuit breakers, call for service.

The trouble shooting guide is broken down into four main sections:

1. System Power
2. Electronics Console
3. Ball Console
4. Bingo System

Isolate your particular problem to one of these sections and then refer to that section for guidance.

System Power Issues:

Problem	Possible Cause	What to do or check
Electronics and Ball consoles have no power	Hall power not available	Check hall fuses or circuit breakers
	Outlet strip #2 power cord not plugged into hall power or outlet switch not on	Plug cord into 120 VAC, grounded power source
	UPS power switch not ON	Depress power ON switch
	UPS circuit breaker tripped	Depress UPS circuit breaker button on the back of the UPS
Power available, but Electronics console equipment not powered correctly	Dell AC cord unplugged from UPS	Plug in Dell power cord to UPS1 socket as shown in the Appendix
	Dell computer turned off	Depress power ON button on Dell computer
	Operator Monitor AC cord unplugged from UPS	Plug in Operator Monitor AC cord to UPS2 socket as shown in the Appendix
	Operator Monitor turned off	Depress Monitor ON switch on the front panel of the monitor
	AC Outlet Strip 1 not plugged into UPS	Plug strip into UPS as shown in the Appendix. Note that strip 1 must go into UPS3 socket.
	AC Outlet Strip 1 or 2 circuit breaker tripped	Reset outlet power switch to ON position
Power available, but Ball console equipment not powered correctly	AC power cord to Ball console not plugged into Electronics console	Plug in power cord to Outlet strip #2 socket as shown in the Appendix
	Blower motor unplugged or blower motor circuit breaker tripped	Inside the blower motor compartment, check that the AC power cord is plugged into the outlet. Reset the breaker switch on the outlet
	Blower motor switch OFF	Place the switch on the ball tray to the ON position
UPS did not work properly when AC power failed	UPS defective or battery pack worn or defective	Call for service to replace the UPS
UPS is beeping	Low AC line voltage	Specification in Appendix

Electronics Console Issues:

Problem	Possible Cause	What to do or check
Operator Monitor touch panel not operating properly	Touch panel calibration	Calibrate the touch panel using Utilities provided
	Touch panel defective	Call for service
	Touch panel cable unplugged	Plug in cable to Dell and/or Monitor as shown in Appendix
	Dell computer defective	Call for service
Operator Monitor video image	Monitor data cable unplugged	Plug in cable to Dell and/or Monitor as shown in Appendix
	Display defective	Call for service
	Dell computer defective	Call for service
Operator Monitor audio	Monitor audio cable unplugged	
	Monitor speakers defective	Call for service
	Dell computer defective	Call for service
Magnetic card reader	Cable unplugged	Plug in cable to Dell as shown in Appendix
	Defective reader	Call for service
	Dell computer defective	Call for service
Data Router status LEDs not on	Data Router software	Depress the Data Router Reset switch
	Data Router AC adapter unplugged	Plug Adapter into Outlet 1 as shown in Appendix
	Data Router fuse blown	If the power ON LED is off, check or replace the fuse
	Defective AC adapter	If the power ON LED is off, and fuse is good, call for service
	Communications cable to Dell unplugged	Plug in cable to the Data Router and/or to Dell COM1 as shown in Appendix
	Dell computer defective	Call for service. In the meantime, try Manual Mode operations

Electronics Console Issues (continued):

Problem	Possible Cause	What to do or check
Particular Data Router flashboard LED and associated flashboards not working	Individual flashboard driver fuse blown	Transfer flashboard cable to an unused connector, if available. If not available, call for service
Dell computer not operating properly	Program misoperating	Exit the program and do an orderly shutdown of the Dell. Power the Dell OFF with its power switch. Shut off the UPS with the UPS OFF switch. Power the UPS back ON. Power the Dell back ON. If still not operating properly, call for service and try Manual Mode operations.
	Excessive noise on the AC power line	Provide cleaner AC power to the system
	Corrupted hard drive	Place Operating System CD Disk #1 in CD drive and restart Dell computer. Follow instructions on screen loading all Operating System CDs then Applications CD and last the Console Backup CD of your database.
	Dell computer defective	Call for service.
Cooling fan not operating	AC power unplugged	Plug in power cord to Outlet strip as shown in Appendix
	Defective fan	Call for service
Monitor arm	Defective or broken	Call for service
Light on graphics panel	Blown bulb	Replace bulb
	AC power unplugged	Plug in power cord to Outlet1 strip as shown in Appendix
	Defective equipment	Call for service
Mouse or keyboard	Cable(s) unplugged	Plug in cable(s) to Dell as shown in Appendix
	Defective equipment	Call for service

Electronics Console Issues (continued):

Problem	Possible Cause	What to do or check
Printer (optional equipment)	AC power cord unplugged	Plug in power cord to Outlet strip as shown in Appendix
	Communications cable unplugged	Plug in cable to Dell and/or Printer as shown in Appendix
	Print quality, ink cartridge	Replace cartridge
	Defective equipment	Call for service
VCR (optional equipment)	AC power cord unplugged	Plug in power cord to Outlet strip as shown in Appendix
	Video cable unplugged	Plug in cable as shown in Appendix
	Defective equipment	Call for service

Ball Console Issues:

Problem	Possible Cause	What to do or check
Blower motor	No AC power, On/Off switch, circuit breaker tripped	Check procedures under System Power troubleshooting
Poor bingo ball action	Clogged blower air filter	Replace filter
	Low line voltage	Specification in Appendix
	Excessive static	Make sure anti-static band is installed in the bottom of the ball chamber. If it is installed, call for service
	Lid on inner ball chamber misaligned	Check for proper seating of the lid and that ball extraction tube is centered over blower hole
	Defective blower motor	Call for service
None of the ball tray switches work	Data Router or Ball Tray software	Depress Reset switch on the front of the Data Router
	Communications cable unplugged	Plug in Ball Tray cable to Data Router as shown in Appendix
	Defective Ball Tray	Call for service. In the meantime, use the touch panel on the Operator Monitor to call and reset balls
	Defective Data Router	Call for service
One or a few of the ball tray switches do not work	Defective Ball Tray	Call for service. In the meantime, use the touch panel on the Operator Monitor to call and reset balls

No camera image, and no camera white LEDs are on	Communications cable unplugged	Plug in Camera cable to Dell USB port as shown in Appendix
	Dell computer not turned on	Depress Dell ON switch
	Dell computer defective	Call for service
	Led board defective	Call for service
Camera does not display ball image on Operator Monitor	Program is not on the main Operator gaming screen	Use touch panel to display the main Operating gaming screen
	Camera lens is blocked by foreign material	Remove material from the camera lens area
	Ball tube not centered over camera	Rotate the ball tube until it is centered over the camera
	Camera defective	Call for service
Manual Mode switches do not operate, switch LEDs are off	When the Dell computer is normal, the switches are disabled and LEDs are off.	System OK
Manual Mode switch(s) do not operate when Manual Mode is enabled and LEDs are on.	Defective switch(s)	Call for service.
	Defective Ball Tray	Call for service.
	Defective Data Router	Call for service.
All bingo balls do not return to mixing chamber when the red Door release knob is used	Dirty ball tray chamber	Call for service.
Ball Tray release (two black knobs) do not return to their normal position after releasing balls into the ball tray chamber	Improper ball tray return spring tension or dirt accumulation	Call for service.
Depressing the bingo ball on the ball tray switch works the first time, but not the second time	During a given game, the system disables all repeat actuations of a ball tray switch	System OK. The switch will become active again on Next Game.

Bingo System Issues (as they relate to a Console problem):

Problem	Possible Cause	What to do or check
No video image on the hall Ball Monitor or Message Monitor	Video cable not plugged into the console's RF Modulator or Data Router	Check video cabling as shown in the Appendix
	Video cable between the Dell video card and the RF Modulator or Data Router or VCR not plugged in	Check video cabling as shown in the Appendix
	RF Modulator power cord unplugged	Plug in power cord to the Outlet strip as shown in the Appendix
	VCR turned OFF	Turn on the VCR
	VCR power cord unplugged	Plug in power cord to the Outlet strip as shown in the Appendix
	Defective RF modulator or Data Router	Call for service.
	Defective VCR	Call for service.
Flashboards not operating	Flashboard cable not plugged into the Data Router	Check that cabling is plugged into the correct RJ connector on the Data Router as shown in the Appendix
	Data Router problem	Check Data Router troubleshooting procedures shown above
	Dell computer problem	Check Dell troubleshooting procedures shown above
	Flashboard type not compatible with new Console	Call for service.
Add on Electronic gaming unit system does not work properly with new Console	Not certified by Arrow as compatible	Call for service.

9.1 UPS Status Indicators and Alarms

There are four status indicators (lights) on the front of the UPS.

On Line (GREEN) – is lit whenever utility power is powering the Battery Backup outlets.

On Battery (YELLOW) – is lit whenever the battery of the UPS is powering equipment connected to the Battery Backup Outlets.

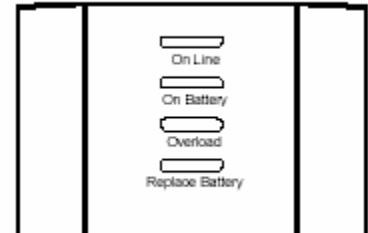

Four Beeps Every 30 Seconds – this alarm is sounded whenever the UPS is running on Battery. There is approximately 10 minutes of run time on batteries. Suggest waiting 1-2 minutes in case the main power is restored then start shutting the Dell computer down in an orderly manner.



Continuous Beeping – this alarm is sounded whenever a low battery condition is reached. Battery run-time is very low. The Dell must be entirely shut down by this time.

Overload (RED) – is lit whenever power demand has exceeded the capacity of the UPS.



Continuous Tone – this alarm is sounded whenever the Battery Backup outlets are overloaded.



Circuit Breaker – the circuit breaker button located on the rear panel of the UPS will stick out if an overload condition forces the UPS to disconnect itself from utility power. Reset the circuit breaker by pushing the button inward.

Replace Battery (RED) – is lit whenever the battery is near the end of its useful life, or if the battery is not connected. A battery that is near end of its useful life has insufficient runtime and should be replaced. **(CALL FOR SERVICE IF THIS OCCURS!)**



Chirps for 1 Minute Every 5 Hours – this alarm is sounded whenever the battery has failed the automatic diagnostic test.

E-max™ BINGO EQUIPMENT LIMITED WARRANTY

Set out below are the terms of the Limited Warranty made by E-max™ Gaming Corporation, Inc. (EGC) in connection with the sale of the Capitol Bingo Equipment (the "Equipment").

1. Limited Warranty

EGC warrants to the original purchaser ('Purchaser') that the Equipment will, for a period of ONE (1) YEAR from the date of original purchase of any Equipment in the 'E-max™' product line from an authorized EGC dealer, be free from manufacturing defects in material and workmanship. Purchaser represents to EGC that no employee, agent, or representative of EGC (or an EGC dealer) has made any representation or warranty regarding the Equipment except as set out herein.

This Limited Warranty applies to normal commercial use and does not cover failures or damage which (a) occurs in shipment; (b) are caused by products not supplied by EGC; or (c) result from accident, misuse, abuse, neglect, mishandling, misapplication, alteration, set-up-adjustments or modifications. This Limited Warranty also does not cover any damage resulting from failure to install the Equipment in strict conformity with both local fire and building codes and regulations, or if the installation does not comply with the installation instructions provided by EGC.

2. Disclaimer of Warranties

EGC MAKES NO WARRANTIES, EXPRESS OR IMPLIED (INCLUDING, WITHOUT LIMITATION, MERCHANTABILITY, FITNESS FOR PARTICULAR PURPOSE, OR AGAINST INFRINGEMENT OF ANY PATENT), EXCEPT AS EXPRESSLY PROVIDED HEREIN. THE EXPRESS WARRANTIES PROVIDED HEREIN ARE IN LIEU OF AND EXCLUDE ALL OTHER WARRANTIES, GUARANTEES OR REPRESENTATIONS, EXPRESS OR IMPLIED, WHETHER ARISING BY OPERATION OF LAW OR OTHERWISE.

3. Limitation of Remedies

If the Equipment supplied does not conform to the Limited Warranty set out above, EGC will, at its option, (a) repair or replace the Equipment, or part thereof, which is defective, or (b) refund so much of the purchase price as Purchaser has paid for the defective equipment, less 1/24th of the purchase price for each month between the date of the purchase from an authorized EGC dealer and the date of the discovery of the defect, provided that written notice of the defect and its nature is given to EGC as soon as practical after discovery of the defect, but in no event later than 90 days from the date of the discovery of the defect.

4. Limitation of Liability

The remedy of repair, replacement, or refund of the purchase price is Purchaser's sole and exclusive remedy and will satisfy all of EGC's liabilities, whether based on contract, negligence, tort, product liability, strict liability or otherwise. **IN NO EVENT WILL EGC BE LIABLE FOR INCIDENTAL OR CONSEQUENTIAL DAMAGES, NOR WILL ITS LIABILITY IN CONNECTION WITH ANY EQUIPMENT OR SERVICE SOLD (INCLUDING NONDELIVERY OR LATE DELIVERY THEREOF) EXCEED THE SALE PRICE OF SUCH EQUIPMENT OR SERVICE.**

5. Warranty Voided

Any obligations of EGC under this Limited Warranty will be deemed to have been satisfied if anyone other than an authorized Capitol Bingo Equipment Dealer services the equipment.

6. Transfer of Limited Warranty

Purchaser may transfer its rights under this Limited Warranty, subject to the terms and conditions hereof, to a buyer ("Buyer") from Purchaser of the Equipment. Thereafter, the rights under this Limited Warranty are not transferable.

For the transfer by Purchaser of the Limited Warranty to be effective, the following conditions must have occurred no later than the 30th day following the date of resale to Buyer:

- A. Purchaser must have complied with all requirements to make the Limited Warranty effective as to Purchaser; and
- B. The Equipment (as an entire unit and as purchased by Purchaser) must be transferred to Buyer.

Upon an effective transfer of this Limited Warranty, Buyer will be considered to be 'Purchaser' for paragraphs 1, 4 and 8 hereof.

7. Inspection

With respect to any claim that the Equipment is defective, EGC will be allowed a reasonable time to inspect the Equipment, in place. If the Equipment is altered or removed before EGC has made such inspection or waived its right to do so, the obligations of EGC under this Limited Warranty will be deemed to have been satisfied.

8. Proof of Purchase

Notwithstanding anything to the contrary in this Limited Warranty, Purchaser must, upon The EGC's request, submit proof of original purchase (satisfactory to EGC) of the Equipment. The Limited Warranty set out above shall not apply to, nor cover, any Equipment for which Purchaser is unable, upon the EGC's request, to supply such proof of purchase.

9. Limitation of Actions

Any legal action against the EGC for a default of its obligations under this Limited Warranty must be commenced within two (2) years from the date the Equipment was sold by an authorized dealer of the Equipment.

10. How to Obtain Service

If a problem with this Equipment develops during or after the warranty period, proceed as follows:

- A. Refer to your Operator's Manual and follow the Troubleshooting Table within the 'Service Section'.
- B. Contact the authorized Capitol Bingo Equipment Distributor from whom you purchased the Equipment.
- C. Contact the Capitol Bingo Equipment Service Manager at the most convenient phone number listed below:

- 1 (800) 321-0757 outside Ohio, but within the U.S.A.
- 1 (800) 537-3479 within the State of Ohio
- 1 (216) 961-3500 within the 216 area code or outside the continental U.S.A.
- 1 (216) 961-3641 fax number in Cleveland, Ohio
- 1 (800) 387-7621 within Ontario
- 1 (519) 770-4621 outside Ontario, but within Canada
- 1 (905) 670-0324 fax number in Canada

SERVICE CALLS WHICH DO NOT INVOLVE DEFECTIVE MATERIALS OR WORKMANSHIP AS DETERMINED BY EGC IN ITS SOLE DISCRETION ARE NOT COVERED. COSTS OF SUCH SERVICE CALLS ARE THE RESPONSIBILITY OF THE PURCHASER.

EGC wants you to remain a satisfied customer. If a problem occurs that cannot be resolved to your satisfaction, please contact us immediately, Phone one of the numbers listed above or write to:

E-max Gaming Corporation
C/o National Service Manager
9900 Clinton Road
Cleveland, Ohio 44144

Please be sure to include the name, model number, serial number, date of original purchase, and the distributor from whom you purchased the Equipment, as well as any actions taken to correct the problem.

11.0 System Utilities

System Utilities takes you through the system administrator and maintenance operations of the E-max Bingo Console. In this section you will learn how to:

- ❖ Create a back up CD of user programming (sessions and games)
- ❖ Restore lost game data
- ❖ Configure the operating system
- ❖ Install software updates
- ❖ Calibrate the touch screen
- ❖ Set the Date and Time
- ❖ Print/save gaming logs
- ❖ Flashboard lamp test

11.1 Back up CD

To Create a back up CD follow the procedure below and refer to figure 11.0

It is highly recommended that backup operations be performed after initial installation, making any changes to the game program or after a software upgrade of the E-max™ operating system.

1. Power up the outlet strip
2. Power up the Back UPS
3. Power up the Dell CPU
4. Log in as the system administrator
5. select **Utilities** from the Main Menu
6. Open the CDRW drive and insert the Arrow Backup CD PN: HH815. (this is the bottom of the two drives)
7. Touch the **Backup** button
8. The backup operation screen will appear
9. Touch the **Backup** button in the center of the screen
10. The time stamp window will appear and ask you if you wish to continue?
11. Touch yes

12. The backup operation will run.
NOTE: This may take several minutes
13. The Backup completed successfully window will appear when the backup operation is complete.
14. Touch **OK**
15. You will be returned to the **Utilities** screen
16. Remove CD from drive and store in a safe place.



Figure 11.0

11.2 Restore lost game data

To restore the user programming, follow the procedure below and refer to figure 11.1

Restoration of user programming is needed after a CPU change, operating system load or other system failure that results in the game information being lost.

1. Power up the outlet strip
2. Power up the Back UPS
3. Power up the Dell CPU
4. Log in as the system administrator
5. select **Utilities** from the Main Menu
6. Open the CDRW drive and insert the Arrow Backup CD PN: HH815. (this is the bottom of the two drives)
7. Touch the **restore** button
8. The restore operation window will appear

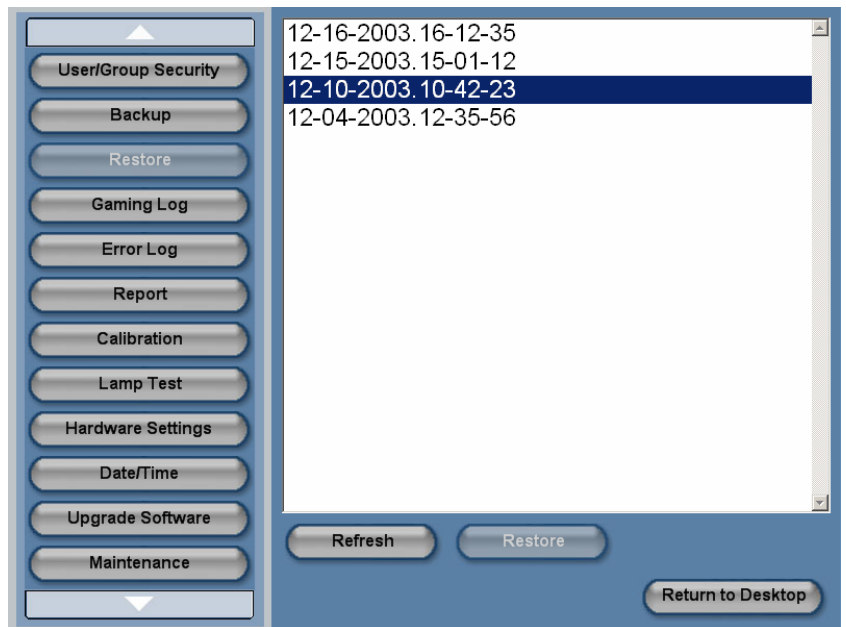

Figure 11.1

9. Touch the **refresh** button
10. A list of the available backups will appear on the screen
11. Select the file you wish to use for the restore by touching the **filename**
12. Touch the **Restore** button
13. The restore operation will operation will run
14. When the restore is complete the **Arrow Recovery** window will appear
15. touch **OK**
16. This will take you back to the system login screen
17. remove the backup CD from the drive

11.3 Configure the operating system

To configure the E-max™ console for RNG or Caller's Choice features, follow the procedure below and refer to figure 11.3

Caution: Check with the local and state laws regarding caller's choice and random number generator before installing these features on the E-max™ Bingo Console

1. Power up the outlet strip
2. Power up the Back UPS
3. Power up the Dell CPU
4. Log in as the system administrator
5. select **Utilities** from the Main Menu
6. Open the CDRW drive and insert the Arrow configuration CD.
(this is the bottom of the two drives)
7. Touch the **Upgrade Software** button
8. The upgrade software operation window will appear
9. Touch the **refresh** button
10. A list of the available software updates will appear on the screen
11. Select the file you wish to install by touching the **filename**
12. Touch the **Install** button
13. The install window will appear
14. Touch **yes**
15. The setup wizard window will appear after a few seconds.
16. Touch **Next**
17. The configuration options window will appear
18. select the options you wish to install by touching the check boxes
19. touch **Next**
20. touch **Finish** when the set up wizard window appears
21. When the configuration is complete the system will reboot and the security login screen will appear
22. remove the configuration CD from the drive



Figure 11.3

11.4 Install Software Updates

To update the E-max™ consoles operating system, follow the procedure below and refer to figure 11.4

Caution: Read the upgrade data sheet provided with the update CD carefully before updating the OS on the E-max™ Bingo Console

1. Power up the outlet strip
2. Power up the Back UPS
3. Power up the Dell CPU
4. Log in as the system administrator
5. select **Utilities** from the Main Menu
6. Open the CDRW drive and insert the Arrow Update CD. (this is the bottom of the two drives)
7. Touch the **Upgrade Software** button
8. The upgrade software operation window will appear
9. Touch the **refresh** button
10. A list of the available software updates will appear on the screen
11. Select the file you wish to install by touching the **filename**
12. Touch the **Install** button
13. The install window will appear
14. Touch **yes**
15. The setup wizard window will appear after a few seconds.
16. Touch **Next**
17. The configuration options window will appear
18. select the options you wish to install by touching the check boxes
19. touch **Next**
20. touch **Finish** when the set up wizard window appears
21. When the configuration is complete the system will reboot and the security login screen will appear
22. remove the configuration CD from the drive



Figure 11.4

11.5 Touch Screen Calibration

To calibrate the E-max™ touch screen, follow the procedure below and refer to figure 11.5

Caution: It is recommended that a small object (a pen tip) be used when calibrating the touch screen. This will ensure the best possible control of the screen for the console operator.

1. Power up the outlet strip
2. Power up the Back UPS
3. Power up the Dell CPU
4. Log in as the system administrator
5. select **Utilities** from the Main Menu
6. Touch the **Calibration** button
7. The calibration screen will appear
8. Touch the **Calibration** button in the center of the screen
9. The calibration screen will run through 9 points on the screen
10. Touch each calibration point as it appears on the screen
11. When all the points are finished you will be returned to the **Utilities** screen

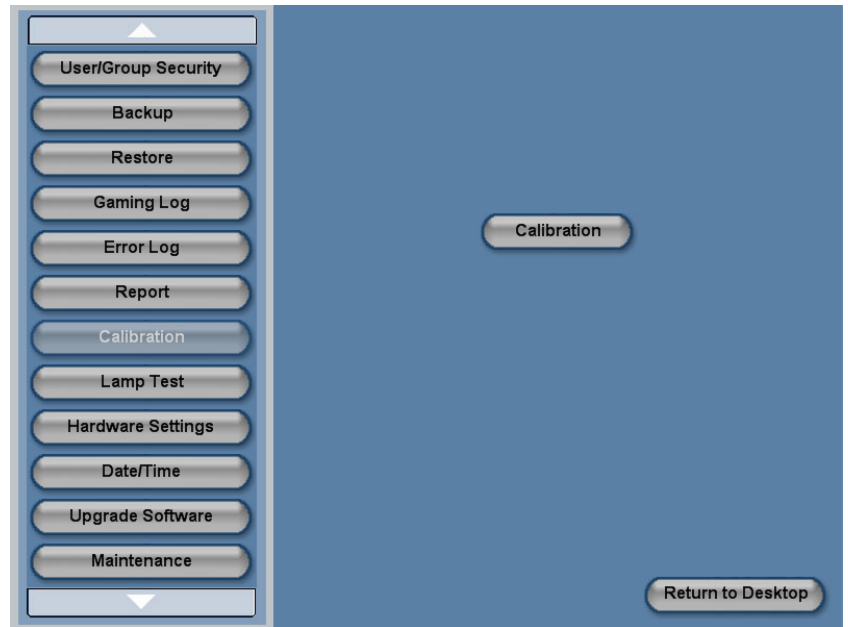

Figure 11.5

11.6 Setting the Date and Time

To set the E-max™ Date and Time, follow the procedure below and refer to figure 11.6

NOTE: The date and time are automatically updated from the CPU clock.

1. Power up the outlet strip
2. Power up the Back UPS
3. Power up the Dell CPU
4. Log in as the system administrator
5. select **Utilities** from the Main Menu
6. Touch the **Date/Time** button
7. The Date/Time settings screen will appear
8. Touch the **Date** drop down menu to adjust the date
9. Touch the **Time** (arrow up/Down) to adjust the time
10. Touch the **time zone** drop down menu the set the time zone
11. Select the check box to allow for daylight savings time



Figure 11.6

11.7 Testing the Flashboards

To test the hall flashboards, follow the procedure below and refer to figure 11.7

NOTE: Lamp test is performed from the console utilities menu.

1. Power up the outlet strip
2. Power up the Back UPS
3. Power up the Dell CPU
4. Log into the system
5. select **Utilities** from the Main Menu
6. Touch the **Lamp Test** button
7. The lamp test screen will appear
8. Touch the **Test** button. (all flashboard lamps should turn on)
9. Touch the **Reset** button to turn the test off



Figure 11.7

11.8 Gaming Log

The E-max Bingo Console keeps a gaming log of all operator actions during a session. To access these logs, refer to the procedure below and figure 11.8

NOTE: If you are going to put these logs on a CD, please ensure that you have a properly formatted, writable media disk in drive #2 of the Dell CPU.

1. Power up the outlet strip
2. Power up the Back UPS
3. Power up the Dell CPU
4. Log in as the system administrator
5. select **Utilities** from the Main Menu
6. touch the **Gaming Log** button
7. Touch the **Schedule name** drop down menu and select the session you want a log for
8. Touch the **Date** drop down menu to select the date you want a log for
9. Touch the **Print** button. (This will print out the log)
10. Touch the **write to disk** button if you want the log burned to a data CD
11. Touch the **Delete** button to delete the report

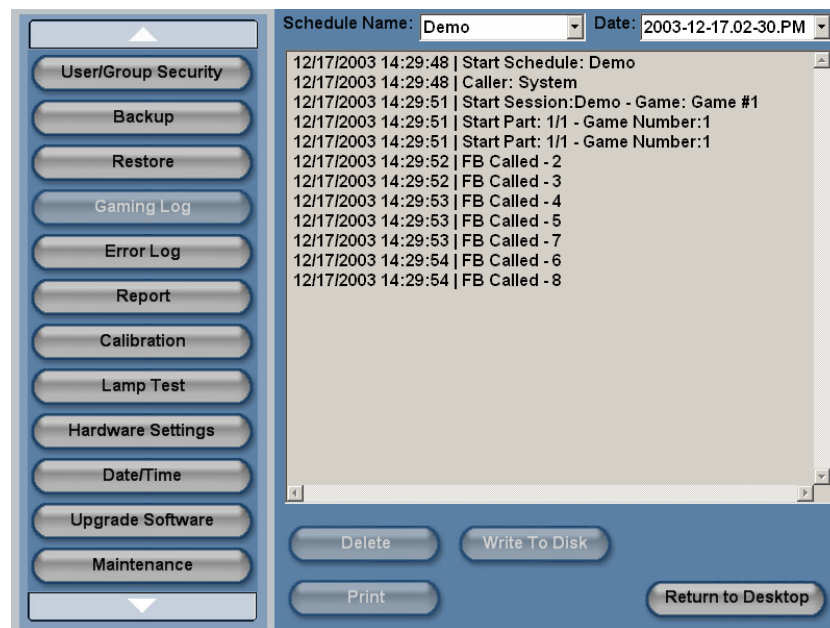

Figure 11.8

11.9 Payout Report

The E-max™ Bingo Console keeps a gaming report of all games played, faces verified and winner payouts during a session. To access this report, refer to the procedure below and figure 11.9

NOTE: If you are going to put these Reports on a CD, please ensure that you have a properly formatted, writable media disk in drive #2 of the Dell CPU.

1. Power up the outlet strip
2. Power up the Back UPS
3. Power up the Dell CPU
4. Log in as the system administrator
5. select **Utilities** from the Main Menu
6. touch the **Payout Report** button
7. Touch the **Schedule name** drop down menu and select the session you want a report for
8. Touch the **Date** drop down menu to select the date you want a report for
9. Touch the **Print** button. (This will print out the report)
10. Touch the **write to disk** button if you want the report burned to a data CD
11. Touch the **Delete** button to delete the report



Figure 11.9

11.10 Gaming Log

The E-max™ Bingo Console keeps a gaming report of all games played, faces verified, Ball Tray Activity and winner payouts during a session. To access the Gaming Log, refer to the procedure below and figure 11.10

NOTE: If you are going to put these Reports on a CD, please ensure that you have a properly formatted, writable media disk in drive #2 of the Dell CPU.

1. Power up the outlet strip
2. Power up the Back UPS
3. Power up the Dell CPU
4. Log in as the system administrator
5. select **Utilities** from the Main Menu
6. touch the **Gaming Log** button
7. Touch the **Schedule name** drop down menu and select the session you want a report for
8. Touch the **Date** drop down menu to select the date you want a report for
9. Touch the **Print** button. (This will print out the report)
10. Touch the **write to disk** button if you want the report burned to a data CD
11. Touch the **Delete** button to delete the report

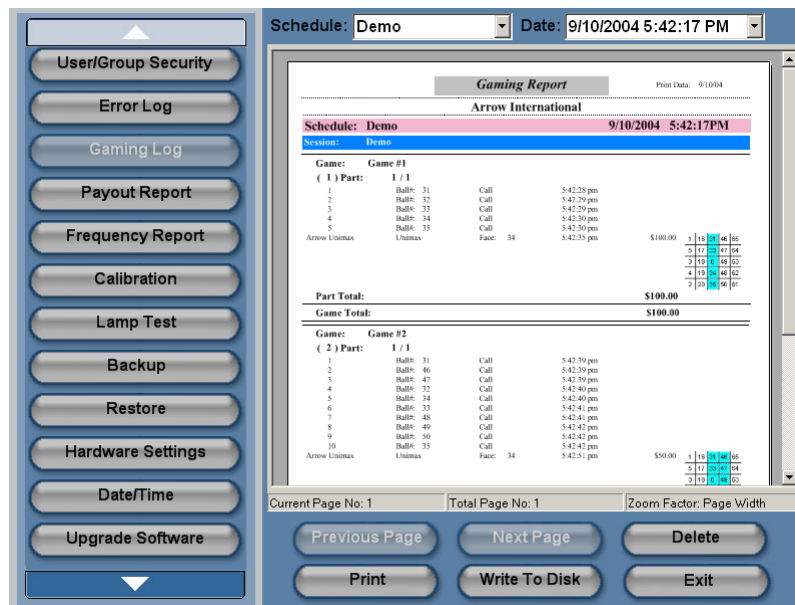

Figure 11.10

11.11 Ball frequency Report

The E-max™ Bingo Console keeps a gaming report of all games played, faces verified, Ball Tray Activity and winner payouts during a session. To access the Ball Frequency Report, refer to the procedure below and figure 11.11

NOTE: If you are going to put these Reports on a CD, please ensure that you have a properly formatted, writable media disk in drive #2 of the Dell CPU.

1. Power up the outlet strip
2. Power up the Back UPS
3. Power up the Dell CPU
4. Log in as the system administrator
5. select **Utilities** from the Main Menu
6. touch the **Frequency Report** button
7. Touch the **Schedule name** drop down menu and select the session you want a report for
8. Touch the **Date** drop down menu to select the date you want a report for
9. Touch the **Print** button. (This will print out the report)
10. Touch the **write to disk** button if you want the report burned to a data CD
11. Touch the **Delete** button to delete the report

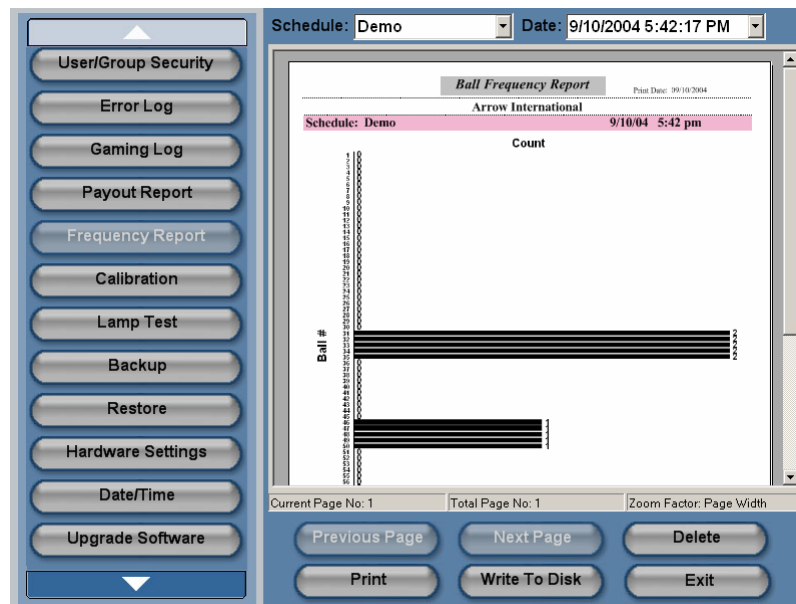

Figure 11.11

11.12 Hardware Settings

The E-max™ Bingo Console can be installed as a single or double blower unit. If your installation is a double, you must configure the Dell CPU to recognize the two ball cameras. Refer to the procedure below and figure 11.12

1. Power up the outlet strip
2. Power up the Back UPS
3. Power up the Dell CPU
4. Log in as the system administrator
5. select **Utilities** from the Main Menu
6. Touch the **Hardware Settings** button
7. Touch the **Double Blower** setting
8. Touch the **Save** button



Figure 11.12

This Screen also displays the revision level and release date of the Data Router and the revision level of the operating system.

Console Diagrams



This Section contains diagrams to help you configure the E-max™ Bingo Console.

In this section there are diagrams for:

- ❖ Operator Console Block Diagram
- ❖ Dell System Connectors for Video and Peripherals
- ❖ Video and Audio Connections Block Diagram
- ❖ Peripheral Device Connections Block Diagram
- ❖ AC Power Connections
- ❖ Data Router Console Side Connections
- ❖ Data Router Field Side Connectors
- ❖ Data Router Field Connector Pin Definitions
- ❖ RF Modulator Connectors

Operators Console Block Diagram

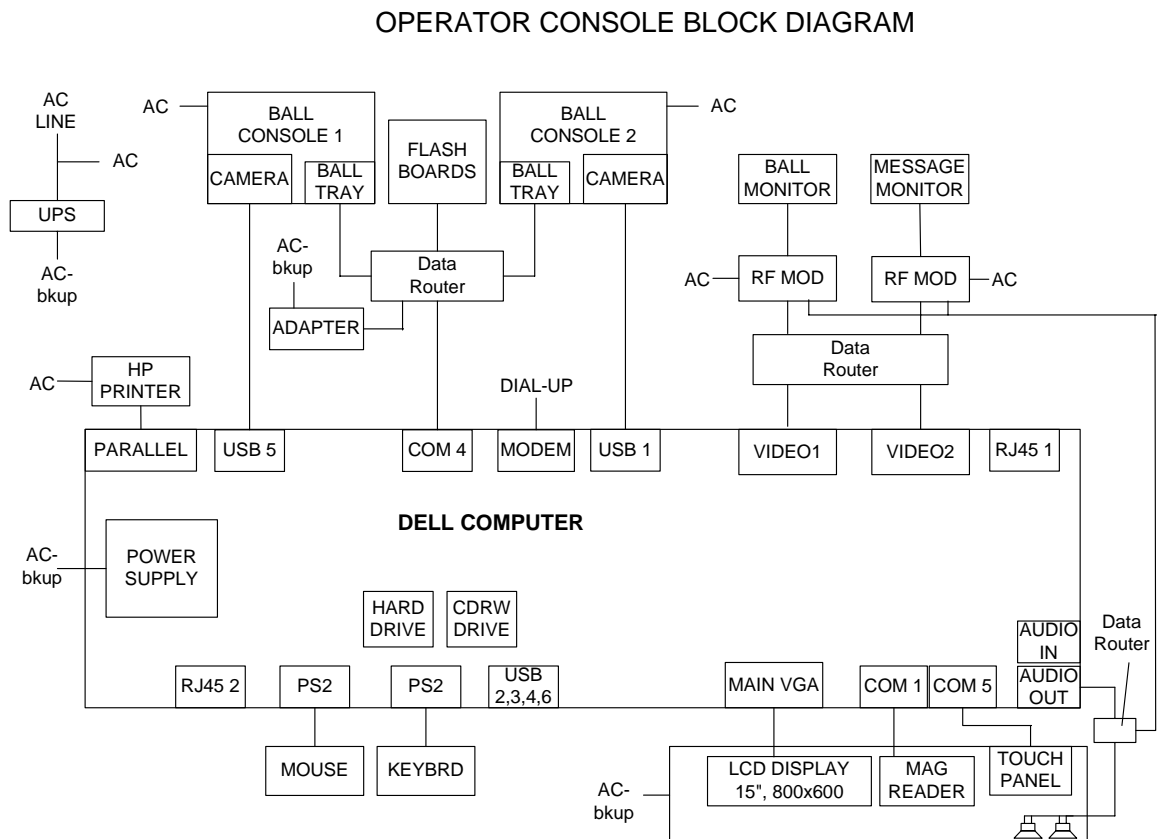

Dell System Connectors Peripherals Diagram GX270

DELL I/O CONNECTIONS

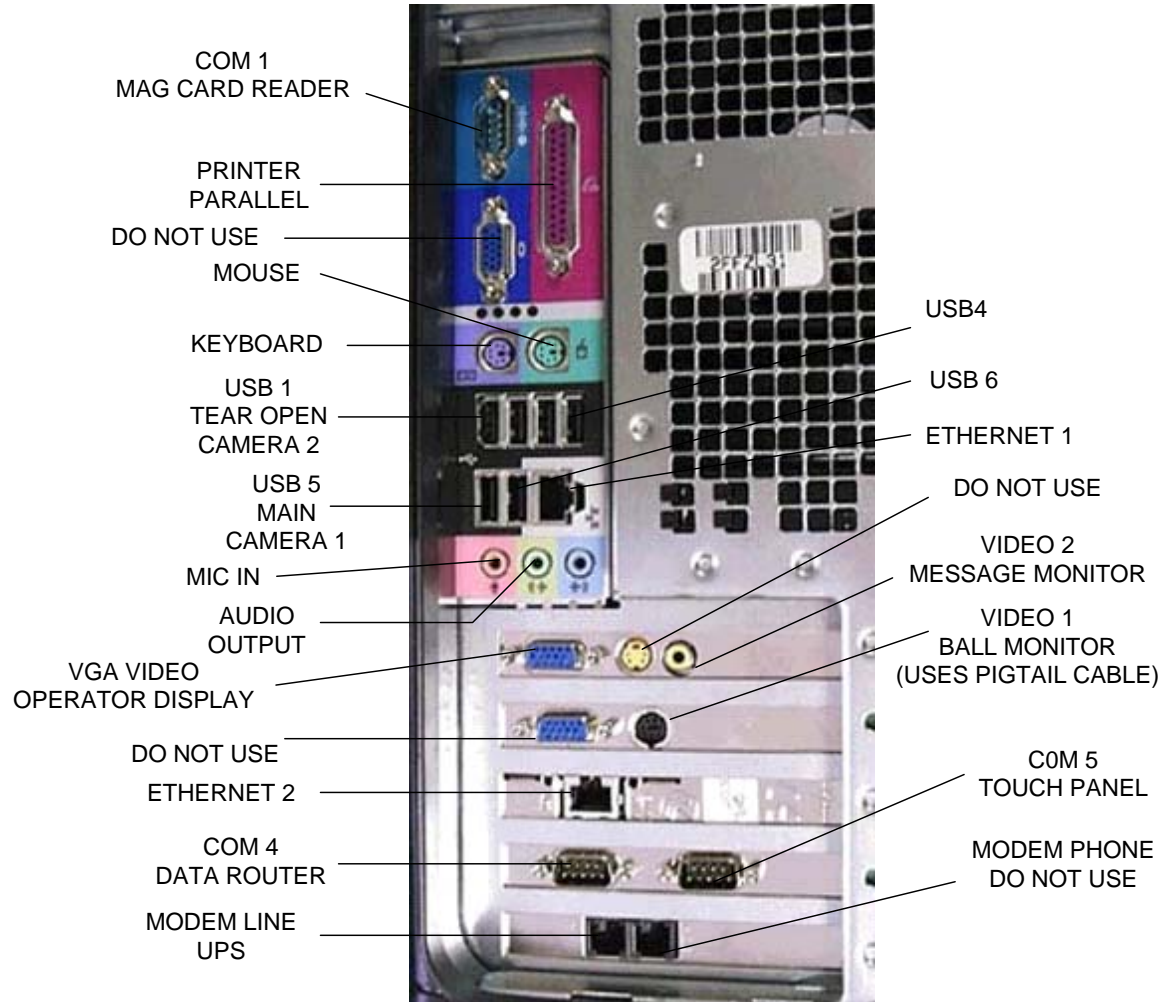

Video and Audio Connections Block Diagram GX270

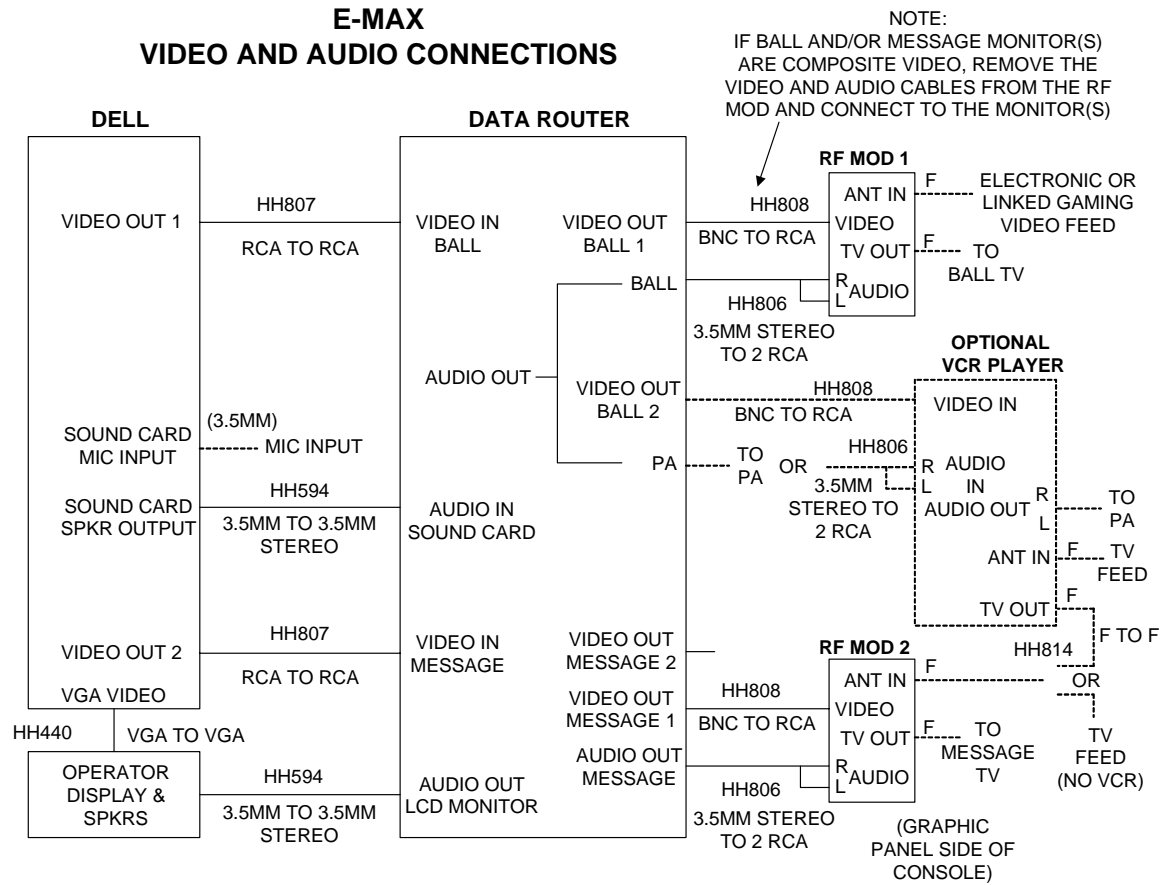

Dell System Connectors Peripherals Diagram GX280

Dell I/O GSX 280 Connections

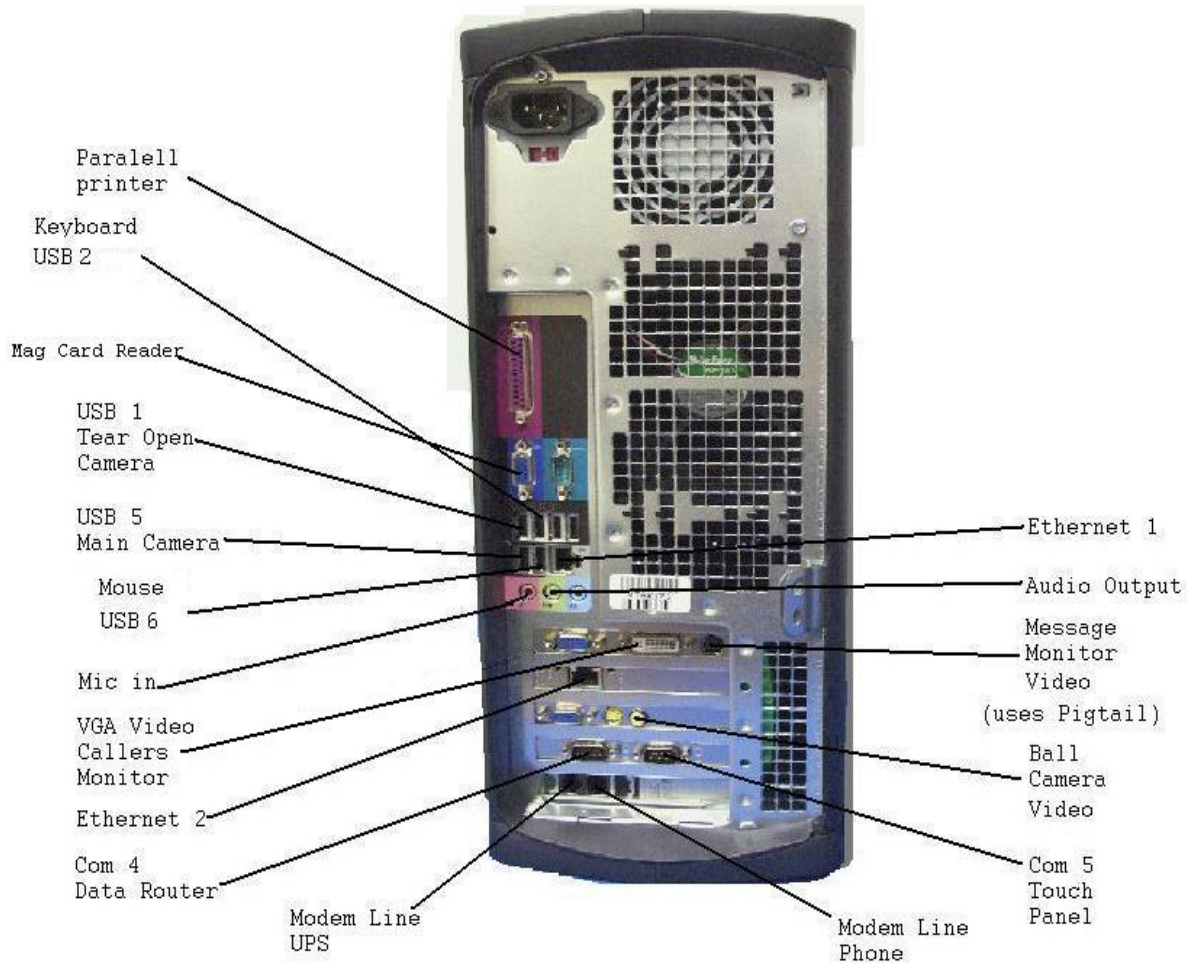

Peripheral Device Connections Block Diagram GX280

E-MAX PERIPHERAL DEVICE CONNECTIONS

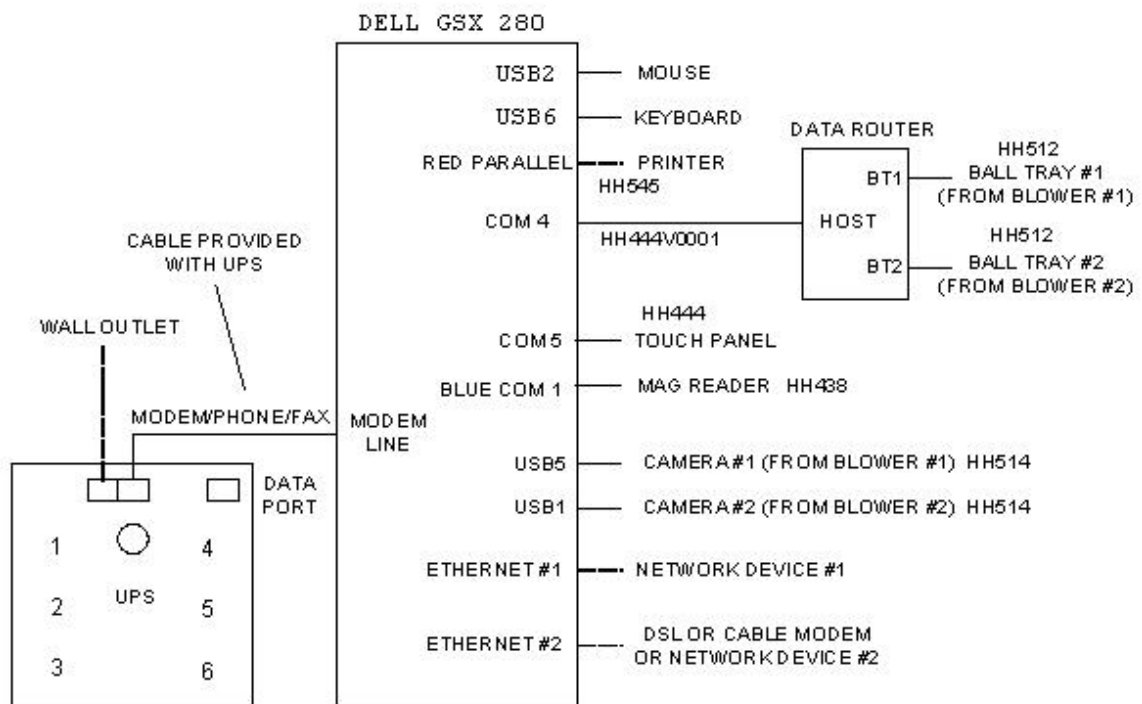

Peripheral Device Connections Block Diagram GSX 270

E-MAX PERIPHERAL DEVICE CONNECTIONS

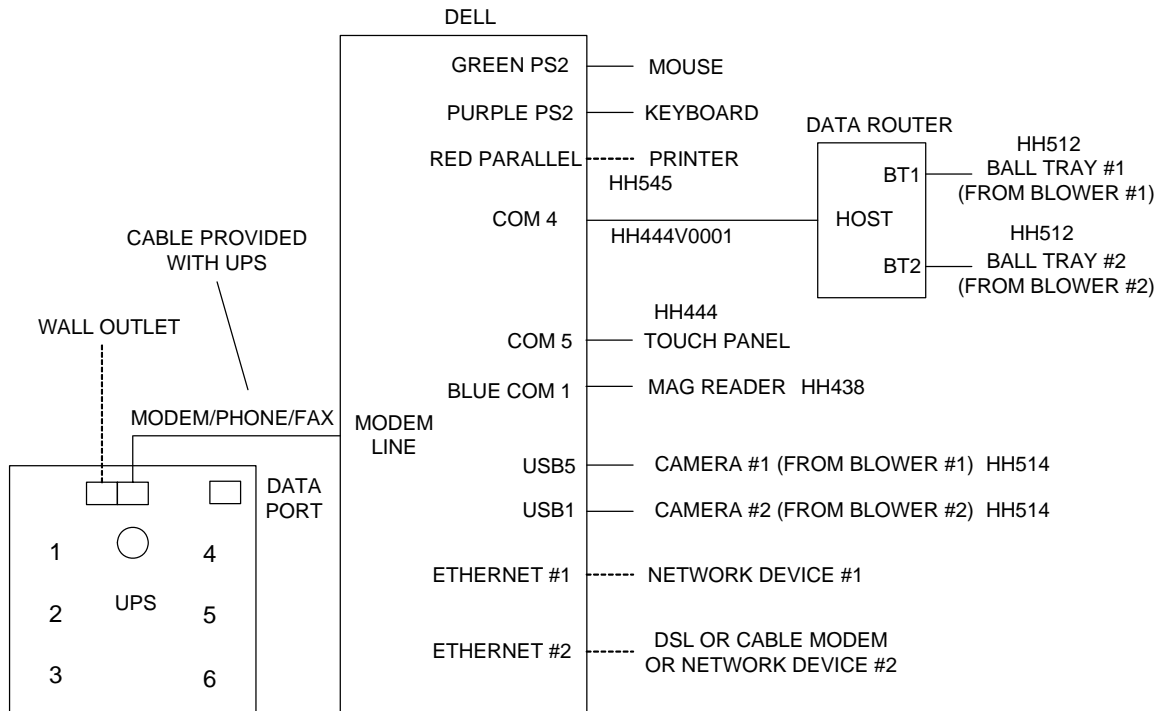

AC Power Connections

E-MAX AC POWER CONNECTIONS

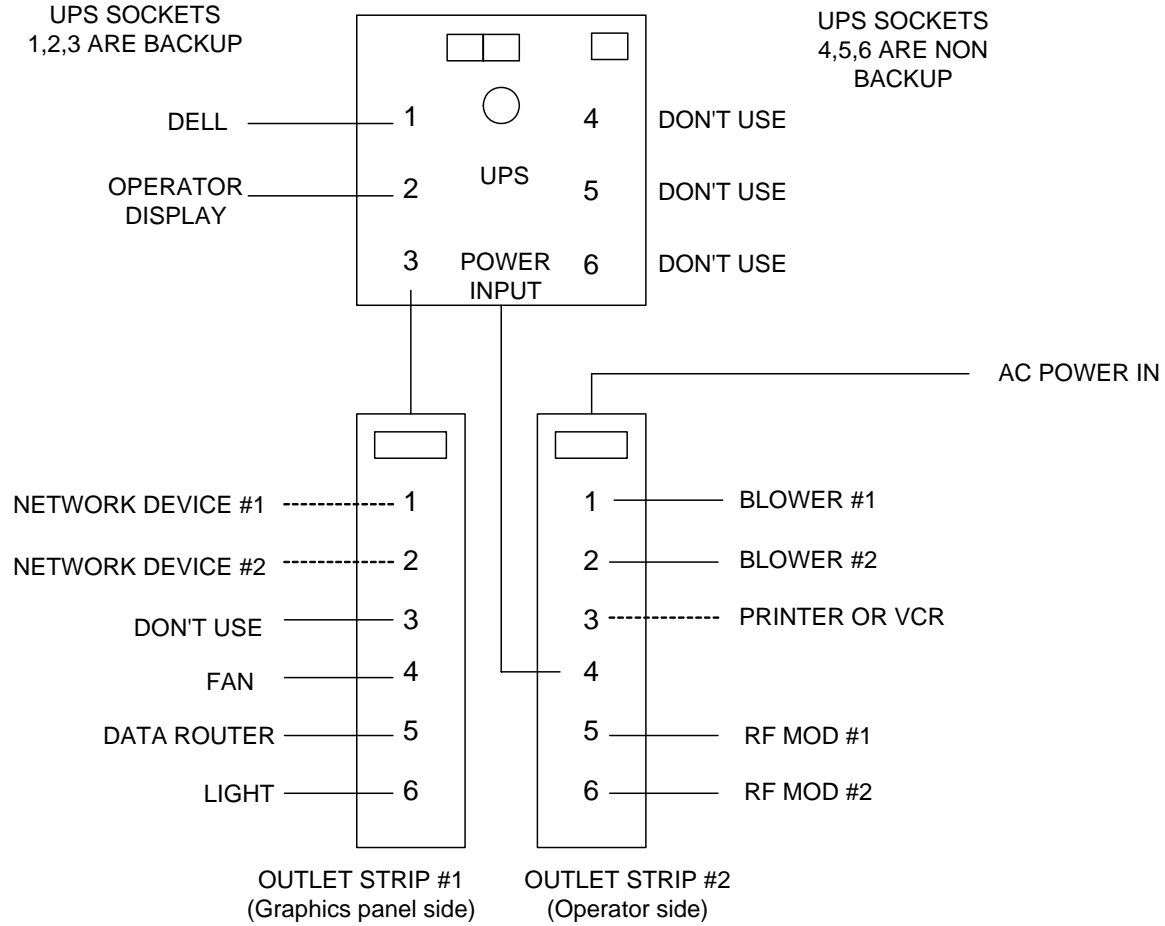

Data Router Console Side Connections

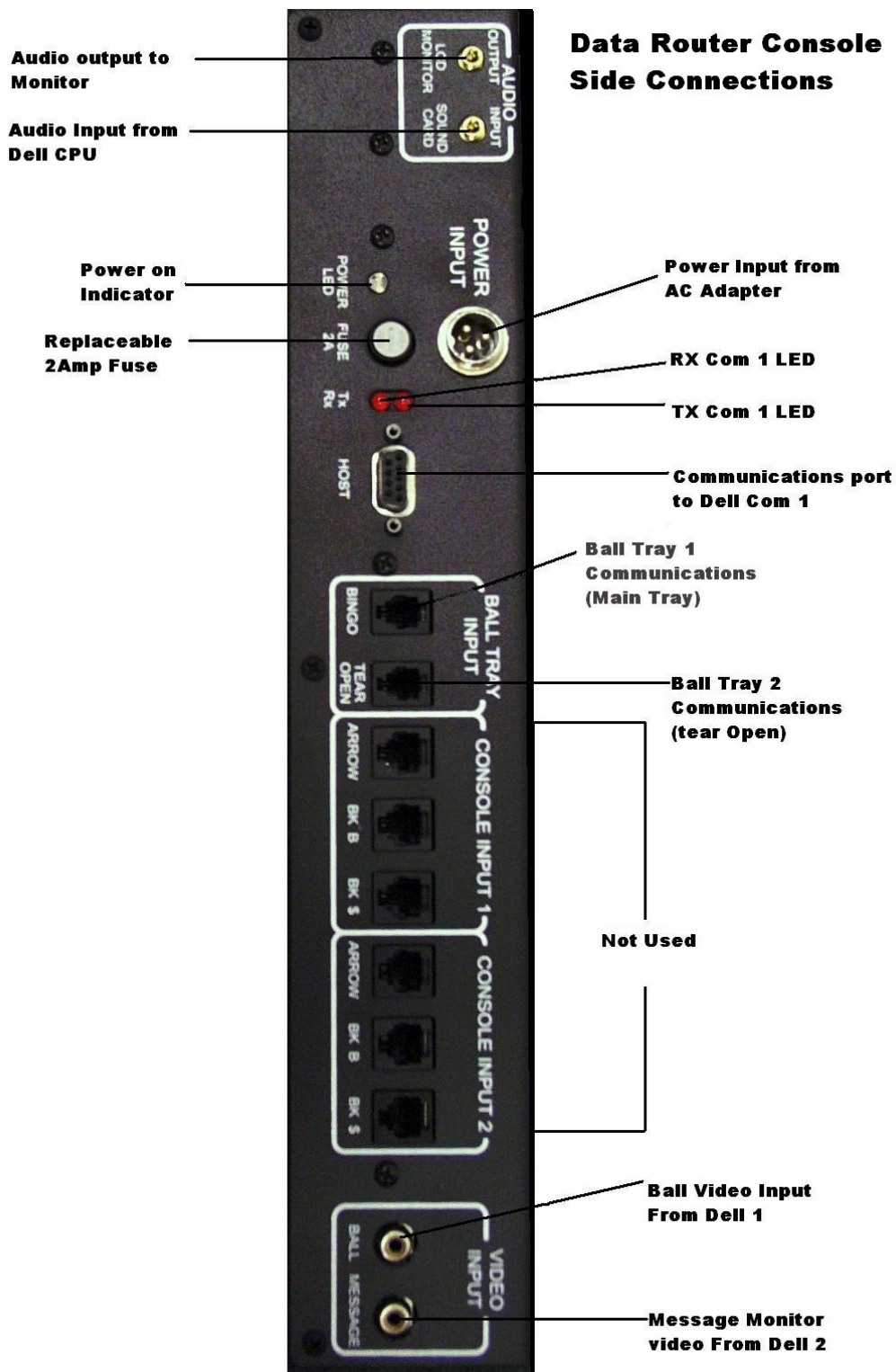

Data Router Field Side Connections

Data Router Field Connections

Audio out to Ball Monitors Mod 1

Audio output to PA System (audio in)

Audio Output to Message Monitors Mod 2

BK Payout Both outputs

BK Data Both Outputs

Main Flashboard outputs

Arrow Flashboard Outputs

Composite Video to Message Monitors

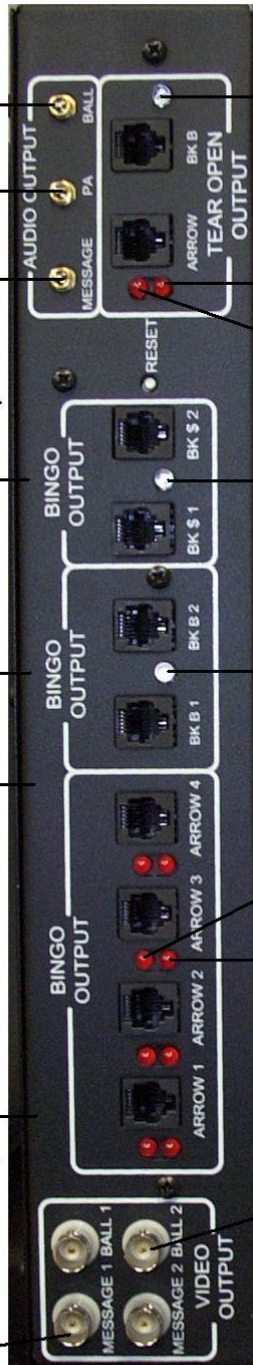

BK B Data LED

Game Indicator LED

Dollar Value LED

BK Payout LED

BK Data LED

Dollar Value LED (4 places)

Game Indicator LED (4 places)

Composite Video to Ball Monitors

Data Router Field Connector Definitions



RF Modulator Video Connections Diagram

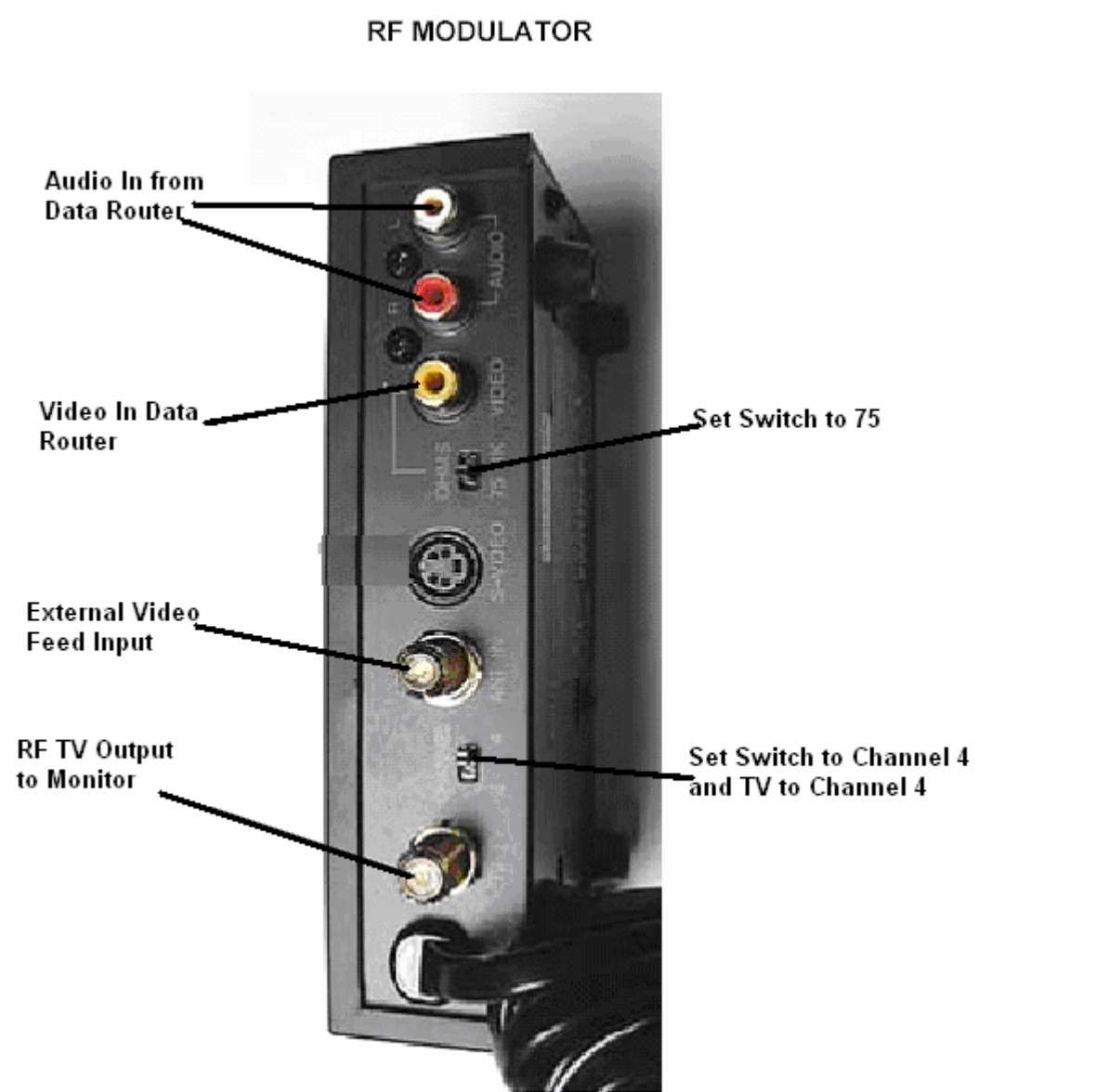

E-max™ Bingo Console

Specifications

Appendix

B

Disclaimer:

Not all consoles are shipped with identical specifications and equipment and the following specifications are intended as a base line reference for the performance of the E-max product line. Specifications are subject to change without notice because of the dynamic aspect of the computer hardware and software marketplace.

General Features of Electronics Console:

Slate gray wood cabinet with black trim, modular design
Heavy duty casters, rear locking front non-locking
Three key locks, two keys each
Sliding drawer for storage or printer or VCR
Graphics panel with light, standard Arrow artwork (HH525 Light Replacement)
UPS, Internal, 10 minute backup
Dell Computer:
 Intel 2.4 GHz P4 CPU
 512 MB RAM, 40 GB hard drive, CDRW drive,
 Sound, 3 video ports, 6 USB ports,
 1 parallel port, 3 serial ports, 2 Ethernet ports,
 Full size keyboard, mouse
Operator display:
 15" color LCD flat display:
 Touch panel, speakers, magnetic card reader
Data Router:
 4 Arrow main flashboard outputs, each with both G.I., \$value and status LEDs
 2 BK B main flashboard outputs with status LEDs
 2 BK \$value flashboard outputs with status LEDs
 1 Arrow & 1 BK Tear Open flashboard output with status LEDs
 2 independent composite video outputs with RCA connectors
 Software switched external video to two RF modulators
 Software switched audio to operator display, monitors, PA system
 Manual back up mode when Dell computer fails
Two RF modulator outputs for TV monitors, each with an RF input for external video
Operator Manual
CDs- restore application, database, and blank backup
Magnetic card reader for security access
1 year warranty

General Features of Ball Console

- 75 ball console
- Slate gray cabinet with black trim, modular design
- Red / Green / Silver ball chamber
- Arm rest
- Heavy duty casters, rear locking, front non-locking
- Sealed Ball bearing blower motor with power on/off switch
- Hepa air filter (HH246 Filter Replacement)
- Anti-static control and metal ball tube
- Dual ball chambers for reduced noise
- Integrated digital camera
- LED ball illumination
- Spill resistant rubber ball switches
- Raised ball for easy removal from ball tray
- Integrated ball tray computer
- Filler panels with cup holder and mounting rails to adjoin consoles
- 1 set of double numbered bingo balls
- Operator manual
- 1 year warranty

Detailed System Specifications

Size:

Electronics console:

27.5" wide x 34.5" deep x 30" high, + 17" high for the monitor
196 lbs

Ball console:

40.5" wide x 34.5" deep with arm rest, x 30" high, +4.5" high for ball tube
165 lbs

Electronics and Ball console adjoined: 69" wide

Electronics and two Ball consoles adjoined: 109" wide

Environment:

Indoor use only, no condensation

Recommended Operating Temperature: 15C to 35C (59F to 95F)

Storage temperature: -5C to 45C (23F to 113F)

Regulatory:

C-UL US Listing (pending)

Electrical:

Flashboard outputs:

0 to 5V output, up to 150ma sink or source, short circuit and ESD protected
Fused for severe damage

Video outputs:

Composite video – 0 to 5V max, 75 ohm output, RCA jack
RF modulator – channel 3 or 4, 75 ohm output, Type F connector

Video inputs:

RF signal level from TV out or similar source, Type F connector

Audio outputs:

0 to 5V max, signal levels and output impedance not intended to directly drive speakers, stereo 3.5 mm receptacle

Audio input:

Signal levels compatible with standard PC sound card, MIC IN circuitry.

Power Input:

60 Hz, 115 VAC nominal, 103 VAC min, 126 VAC max

Service feed wire must be 14 AWG or better and must be able to support 15 A.

Power should be reasonably free of noise and large surges.

Console will operate and provide fluorescent emergency lighting for up to 10 minutes in the event of a power failure

Gaming Related Specifications:**Software Architecture:**

MSWindows XP Pro operating system with custom Arrow gaming application shell.

Gaming operator never has access to the Windows operating system

Perms:

Verifies all Arrow paper perms – other perms available on special request

Tracks paper serial numbers

Security:

Three levels of system security for personnel access to equipment and gaming operations

User can change password

Encrypted hard drive and mechanical lock on Dell computer for maximum gaming security

Loads only Arrow generated gaming CDs

Operations:

Supports multiple organizations and multiple sessions on one console with security access

Operator can interchangeably use touch panel, keyboard, or mouse for input

Balls wrongly inserted in the ball tray can be easily reset on the operator screen

Live, digital ball camera image (picture-in-picture) on operator screen

Supports two cameras from the double ball console configuration

Automatically displays correct ball image and enables correct ball tray switches

Supports multilevel payouts and generates payout report

Hundreds of factory pre-loaded game patterns

Powerful, yet easy to use new pattern generator

Logs all gaming activity to a file which can be printed or recorded on a CD

Back up CDs can be generated to protect gaming setups and database

Console Operator Manual stored on the hard drive

Multi-media:

Sends dynamic or pre-programmed text or image ads to the Message monitor

Play Power Point presentations to the Message monitor

Dynamic or pre-programmed software controlled switching of interval and external video and audio signals

Supports external TV feed to the Message monitor

Supports VCR video, external linked gaming video, or other verify video to the Ball monitor

Networking:

Two Ethernet ports for maximum flexibility. (Customer specific applications)

Internal 56 K modem

Remote dial out application software – Future option

Wiring Diagrams

Appendix

C

AC Outlet

